

# The Failure of a Clearinghouse: Empirical Evidence\*

Vincent Bignon<sup>†</sup>      Guillaume Vuilleme<sup>‡</sup>

November 21, 2016

## Abstract

We provide the first empirical description of the failure of a derivatives clearinghouse. We use novel, hand-collected, archive data to study risk management incentives by the Paris commodity futures clearinghouse around its failure in 1974. We do not find evidence of lenient risk management during the commodity price boom of 1973-1974. However, we show strong distortions of risk management incentives, akin to risk-shifting, as soon as prices collapsed and a large clearing member approached distress. Distortions persist during the recovery/resolution phase. Theoretically, these distortions suggest that capitalization and governance were weak, but do not imply that moral hazard was significant before the failure. Our findings have implications for the design of clearing institutions, including their default management schemes.

---

\*We are grateful to Darrell Duffie, Christophe Pérignon and Martin Scheicher for comments. We thank several employees at the French National Archives, at the Archives of the Ministry of Finance (CAEF), at the Archives of the Bank of France, and at the Archives of the Paris Chamber of Commerce for helping us locating relevant documents. Guillaume Vuilleme thanks the Chair ACPR/Risk Foundation: Regulation and Systemic Risk and the Investissements d'Avenir (ANR-11-IDEX-0003/Labex Ecodec/ANR-11-LABX-0047) for supporting this work. The views expressed in this paper are those of the authors and do not necessarily reflect those of the Banque de France or of the Eurosystem.

<sup>†</sup>Banque de France. Email: [vincent.bignon@banque-france.fr](mailto:vincent.bignon@banque-france.fr).

<sup>‡</sup>HEC Paris and CEPR. Email: [vuilleme@hec.fr](mailto:vuilleme@hec.fr).

# 1 Introduction

The orderly settlement of transactions is essential for the functioning of financial markets. In both over-the-counter and exchange-based markets, clearing and settlement is often performed by a clearinghouse, or central clearing counterparty (CCP). Once two parties agree on a transaction, a CCP interposes itself between them, thus becoming a buyer to the seller, and a seller to the buyer. After this process, called “novation”, the CCP guarantees the settlement of the trade and insulates each party from counterparty risk. Because central clearing is expected to prevent market disruptions due to the failure of large financial institutions, regulators around the world now mandate the use of CCPs for standardized derivatives (Duffie, Scheicher, and Vuilleme, 2015), or push for more widespread central clearing in the repo market. However, a new risk arises: when a market is centrally cleared, all traders are exposed to the CCP. Therefore, the failure of a CCP could have dramatic consequences for markets and macroeconomic stability (Duffie, 2015). While heavily discussed in academic and policy circles, CCP defaults are rare events and the actual default of a CCP has never been studied.

We provide the first empirical analysis of the failure of a CCP. We hand-collect rich archive data to study the failure of the *Caisse de Liquidation des Affaires et Marchandises* (CLAM) in Paris in 1974. The CLAM was the only clearinghouse operating in the Paris Commodity Exchange, a market for cocoa, coffee and sugar futures, the latter being the most active segment. Between 1973 and 1974, a six-fold increase in global sugar prices spurred trading activities. Starting in November 1974, the collapse of sugar prices triggered margin calls for investors with long future positions, and induced the largest clearing member to default. This default led to a temporary closure of the market, and ultimately to the failure and resolution of the CLAM.

Our first contribution is to provide descriptive evidence on the actual default of a CCP. We collect comprehensive data on the exposures of all market participants: the CLAM, retail and professional investors, and all clearing members. The exposure data are complemented with daily sugar price data. We also exploit the fact that the CLAM was publicly listed on the Paris stock exchange and collect its daily stock price over ten

years, together with information on equity ownership and governance. Finally, we build a dataset of events specifically related to the CLAM, including all changes in initial margin requirements over a period of one year before the crisis, along with all the main events pertaining to its resolution. We use these data to provide the first quantitative study of the failure of a CCP.

The second contribution is to study the risk management incentives of a CCP both outside and around default. Theory makes different predictions based on whether the CCP is subject to moral hazard or not. If it is not subject to moral hazard, a CCP should engage in efficient risk management, as long as its members are far away from distress (Biais, Heider, and Hoerova, 2016). However, when a large member is in distress and its default could impair the CCP's equity, a form of risk-shifting can imply that the CCP's incentives are distorted (as in Jensen and Meckling, 1976). If the distressed member is called for margins and defaults, the liquidation of its position may impair the CCP's equity, which is bounded below by zero. Instead, if the CCP delays margin calls or the liquidation of defaulted exposures, the distressed member survives with some probability, if a price reversal occurs. In this case, the CCP's equity is not impaired. Risk-shifting theories predict a discontinuous behavior around default: distortions arise only when the CCP is close to the region where its equity value function is convex. A different prediction is obtained if a CCP is subject to moral hazard, e.g., if it expects a bailout in bad aggregate states (Biais, Heider, and Hoerova, 2012). In this case, distortions are to be expected even far away from default. Therefore, there need not be a discontinuous behavior around default in the presence of CCP moral hazard.

We empirically study these distortions. We do not find evidence of lenient risk management by the CLAM during the sugar price boom of 1974. In particular, we show that initial margin requirements were closely aligned with increases in sugar prices, and were set at a higher level than margins in London or New York. We perform events studies on the CLAM's stock price around increases in initial margin requirements, and find evidence of a 2.3% cumulative abnormal stock return five days after the event. This evidence is inconsistent with moral hazard being large. One possible explanation is that the CLAM

was not considered too-big-to-fail, and did not benefit from any implicit bailout guarantee (and indeed was not bailed out ex post).

However, we show that major distortions occurred as soon as sugar prices collapsed and a large clearing member approached distress. In particular, the CLAM failed to declare this member in default early enough, and consequently delayed the liquidation of the member's open position. These results show that the transition from efficient to distorted risk management incentives does not necessarily follow from a slow build-up of imbalances during a boom, but can occur over very short periods, due to large price reversals. Furthermore, we show that incentives by clearing members were also distorted. Outside distress, clearing members are indifferent to execution prices for trades on behalf of their clients, since they act as brokers. Near distress, clients closer to default got orders executed at significantly better prices. This is evidence that clearing members manipulated execution prices, in an attempt to save investors near default and instead call additional margins from investors who were still solvent.

We find that severe distortions persist after the default of the clearing member and during the entire recovery/resolution stage. First, the CLAM strongly supported the temporarily closure of the sugar market, in the hope that it would lead to a settlement price above the market price that then prevailed. Subsequently, the CLAM refused a proposal by sugar professionals to buy the entire position of the defaulted member, which could have allowed the market to quickly reopen. Overall, the CLAM and the defaulting member had aligned interests, at the expense of solvent members.

Theoretically, these distortions in risk management can be understood as risk-shifting. If the CLAM had stuck to its standard risk management principles, by calling margins from the member in distress and by liquidating the defaulted position, its loss could have been large enough to drive its equity value to zero. Instead, more leniency vis-à-vis the member in distress was a risky bet that could preserve its equity value in case of price reversal. Consistent with risk-shifting theories, we show that distortions arise precisely in the region where the CLAM's equity value function was convex, due to limited liability. Furthermore, in this region, we document a high sensitivity of the CLAM's equity value

to changes in the settlement price for outstanding positions, which implies that the set of feasible renegotiation and recovery plans was limited. Indeed, even small concessions by the CLAM vis-à-vis sugar sellers on settlement prices were reducing its equity value significantly. This provides a potential explanation for why the CLAM ultimately did not recover and went through an administered resolution process. We believe similar distortions are likely to arise in other contexts, due to the fact that CCPs are often thinly capitalized compared to their largest potential clearing liabilities.

To summarize, we show that major distortions in CCP risk management may arise even in the absence of significant moral hazard. Therefore, while it contributes to efficient risk management when clearing members are far away from distress, the absence of bailout guarantees is not sufficient to prevent all distortions. Consequently, policies should not only focus on addressing issues arising from moral hazard, even though they are likely to be larger today than in our context, due to the size of modern CCPs and to the fact that mandatory clearing is becoming more widespread. Our results imply that better-capitalized CCPs are desirable. However, given that a CCP's equity value can be extremely sensitive to relatively small changes in settlement prices when a large member is in distress, it seems unlikely that CCPs can reach capitalization levels that completely prevent risk-shifting. In Section 8, we discuss how well-designed default management schemes (so-called “default waterfalls”), which combine tranches of equity with additional resources called from surviving members, can also reduce risk-shifting incentives. Finally, our results suggest that member-owned CCPs, which derive a larger value from the continuation of clearing services, are likely to take better risk management decisions in times of stress. In particular, better governed CCPs may be more reluctant to delay the liquidation of a defaulted member's position — a decision which proved fatal to the CLAM.

One limitation of our study is that it is based on a single event. However, due to the rare nature of CCP defaults (3 cases known in history), no quantitative analysis can be based on a large sample. Within the realm of case studies, ours has a number of attractive features. First, the operations of the CLAM were similar in most respects

to those of modern CCPs. In particular, risk management operated primarily through the collection of initial and variation margins. The CLAM also handled a large trading volume with a diverse population of investors, both foreign and domestic, as well as sophisticated and non-sophisticated. Second, central clearing through the CLAM was mandatory for all transactions on futures on the Paris market. Similarly, central clearing is now mandatory for large asset classes. Mandatory clearing implies that traders cannot choose which exposures to clear centrally or to retain bilaterally, a situation which would give rise to issues that are absent in our context (Koepl, Monnet, and Temzelides, 2012). Third, despite stringent supervision, there was limited government involvement in the operation of the clearinghouse. After the default of the largest clearing member and the closure of the market, the recovery process was left to private parties and to courts, before an administrator was named several months later by the government to manage the resolution of the CLAM. This situation allows us to understand the incentives of market participants both before and after the failure, in a context where an overriding resolution process was not yet in place. In the current context, where CCPs are globalized institutions with clearing members operating across multiple jurisdictions, similar features are likely to be at play. For these reasons, the conclusions we draw are relevant for present-day discussions.

## Related literature

Our paper is the first to empirically study the actual failure of a CCP.<sup>1</sup> The failure of the CLAM had not been studied before, except through a brief account by Simon (1981, Chap. 16), that does not rely on detailed data. Throughout history, we know of only two other examples of CCP failures, that of the Kuala Lumpur Commodity Clearing House in 1983 and that of the Hong Kong Futures Guarantee Corporation in 1987. None of these

---

<sup>1</sup>A related literature studies how central clearing affects market prices and financial stability. Theoretically, Duffie and Zhu (2011) study conditions under which a CCP can reduce counterparty risk, while Acharya and Bisin (2014) show that CCPs decrease counterparty risk in the presence of externalities. Empirically, Bernstein, Hughson, and Weidenmier (2014) show that the introduction of the New York Stock Exchange Clearinghouse in 1892 significantly lowered counterparty risk, contagion risk, and the volatility of returns. Loon and Zhong (2014) also find a reduction of counterparty risk after CDS contracts are cleared.

events has been the object of a detailed study.<sup>2</sup> In October 1987, following the crash in the stock market, clearing and settlement institutions in the US went under severe stress, but did not fail. [Bernanke \(1990\)](#) discusses policy interventions by the Federal Reserve that preserved the integrity of clearing entities. More recently, [Boissel, Derrien, Örs, and Thesmar \(2016\)](#) show that lenders in the repo market behaved as if the probability of CCP default was large during the European sovereign debt crisis.

We study how incentives for a CCP to engage in risk management can be distorted both before and after the default of a large clearing member. As such, our paper relates to the literature on the design of CCP capital structure and loss-allocation mechanisms in default. [Elliott \(2013\)](#) and [Duffie \(2015\)](#) discuss a number of potential loss-allocation rules and resolution mechanisms. While clearing arrangements have to be designed to preserve incentives in default, a key question raised by [Duffie \(2015\)](#) pertains to when a resolution procedure should override contractual arrangements. We show that this question is extremely relevant in our context. More broadly, a few papers consider optimal CCP capital structure and risk management, while not considering CCP default per se. [Biais, Heider, and Hoerova \(2012, 2016\)](#) show that CCPs mutualize counterparty risk, which is not possible under bilateral contracting. While providing insurance, a CCP reduces the incentive of each trader to monitor its counterparties. Appropriately setting margins makes it possible to mitigate the associated risk.<sup>3</sup>

We proceed in [Section 2](#) with a discussion of the theory of risk management by CCPs. Then, in [Section 3](#), we describe the functioning of the Paris Commodity Exchange, the role of the CLAM, and the context of the 1974 crisis. In [Section 4](#), we describe the data. We turn in [Section 5](#) to a study of risk management incentives by the CLAM during the sugar price boom. Finally, in [Sections 6 and 7](#), we show how these incentives were distorted both during the collapse of sugar prices and during the resolution phase. We

---

<sup>2</sup>Official reports were produced in both cases, respectively by the Task Force on the Kuala Lumpur Commodity Exchange, and by [Davison \(1988\)](#). The main goal of these reports is not to analyze CCP failures, but to propose reforms of the organization of commodity exchanges. See also [Norman \(2011, Chap. 9.4\)](#) for a narrative account of the 1987 events in Hong Kong, and [Gregory \(2014\)](#) for a brief description of a few other near-failures.

<sup>3</sup>A separate literature studies the amount of margins necessary to safely clear derivatives. See, for example, [Duffie, Scheicher, and Vuillemeu \(2015\)](#) and [Cruz Lopez, Hurlin, Harris, and Pérignon \(2016\)](#).

conclude and discuss policy implications in Section 8.

## 2 Theoretical discussion

We inform our empirical work with theory. We distinguish between predictions based on whether a CCP is subject to moral hazard or not. The main characteristic of the capital structure of a CCP is that it operates with a *matched book* (Duffie, 2015). For any long position with a counterparty, there is an offsetting position with another counterparty. The operation of a matched book implies that, absent the default of clearing members, the CCP is indifferent about the level of settlement prices and about the distribution of margin calls across investors. Indeed, any variation margin that is collected from an investor is simultaneously paid back to another investor.

When a CCP is not subject to moral hazard, central clearing can improve over bilateral clearing by mutualizing idiosyncratic default risk (Biais, Heider, and Hoerova, 2012). This is true regardless of whether there is moral hazard on the investors' side. Indeed, in this case, the CCP can achieve efficient risk management by appropriately setting margins (Biais, Heider, and Hoerova, 2016). The socially efficient level of margins trades off their opportunity cost (since funds have to be kept in the form of risk-free assets rather than invested) and their incentive benefits, i.e., margins incentivize investors to screen their counterparties before central clearing takes place. The main prediction is that a CCP which is not subject to moral hazard should not have incentives to engage in poor risk management when it operates a matched book, i.e., is far away from distress.

In contrast, when a clearing member is close to default, the incentives of a CCP can be distorted even if it is not subject to moral hazard. Indeed, the CCP still runs a matched book but becomes likely to have an open position in case the member defaults. If the initial margin and default fund contribution paid by the member in distress are insufficient to cover the expected exposure of the CCP, then the CCP's equity is likely to be impaired (Duffie, 2015). If the CCP is well-capitalized, or if its governance structure is such that it attaches enough value to the continuation of clearing services, then it may continue to



take efficient risk management decisions. For example, by calling higher margins from the member in distress and by liquidating the member's position if it does not meet margin calls. The liquidation of a defaulted position possibly at the cost of an equity impairment for the CCP.

Instead, if the capitalization of the CCP is too low, or if its governance is such that managers do not derive large value from continuation, then the CCP has incentives to make decisions that preserve the member in distress. It may tilt the distribution of margin calls towards solvent members, delay margin calls for the member in distress, or delay the liquidation of this member's position. This behavior is akin to risk-shifting ([Jensen and Meckling, 1976](#); [Leland, 1998](#)), as it arises from a convexity in the equity value function. If strict risk management is implemented and the distressed clearing member is not saved, its default may impair the CCP's equity, which is bounded below by zero. Instead, if a more lenient risk management is implemented, the member can survive with some probability, e.g., if a price reversal occurs. In this case, the CCP's equity is not impaired. Therefore, while running a matched book usually implies that the CCP is indifferent about the level and distribution of margin calls, this is not necessarily the case any more when a large clearing member is close to default. The CCP may alter its risk management policy to support the member in distress and increase its expected equity value, possibly at the expense of solvent members. The main prediction of risk-shifting theories is that there should be a discontinuous behavior around distress, such that distortions arise only when the CCP is close enough from the region where its equity value function is convex. A related prediction is that better capitalized CCPs are less likely to engage in risk-shifting strategies.

Finally, additional predictions arise if the CCP is itself subject to moral hazard, e.g., if it expects to be bailed out in a bad aggregate state ([Biais, Heider, and Hoerova, 2012, 2016](#)). In this case, the incentives of the CCP can be distorted even well away from distress. For example, a profit-maximizing CCP can have incentives to reduce margins or to loosen membership requirements, in order to generate higher trading volume. In good aggregate states, it earns higher fees and eventually pays higher dividends. Instead,

it bad states, it expects to be bailed out. For a CCP subject to moral hazard, the main prediction is that distortions are to be expected on a permanent basis, even far away from distress. Therefore, no discontinuous behavior is expected around distress. Another prediction is that distortions should increase when transactions are booming, as moral hazard worsens when the CCP's size increases. Finally, distortions are more likely to arise for CCPs operating in asset classes which are deemed more prone to contagion.

### 3 Institutional background

We start with a description of the Paris sugar futures market, of its clearinghouse, and of the circumstances leading up to its failure in 1974. Additional institutional details are in Appendix [A](#).

#### 3.1 The Paris sugar futures market

Before the 1974 crisis, the Paris sugar futures market was a global and fast-growing marketplace, due to three main factors. First, Paris was the only international market for futures on white sugar. Instead, London and New York offer contracts on brown sugar (see [Simon, 1981](#), for a comparison of the three markets). Second, the Paris market is open to foreign investors and particularly attractive for arbitrage trading in times of high price volatility. Indeed, daily limits on price fluctuations are wider and more flexible than in New York and London. Also facilitating trading by foreign investors is the possibility to register trades concluded after official trading hours (“curb trading”). Third, the liquidity of the market improved significantly over time for hedgers (e.g., sugar producers), due to the increased participation of retail investors. In 1974, less than 1% of traded contracts end up with physical delivery, most contracts being unwound before maturity.

At the center of the trading process are 35 registered commodity brokers (*commissaires agréés*), akin to Futures Commission Merchants in the US. They are the only agents allowed to submit orders and therefore act as intermediaries for other market participants. Brokers do not reveal the name of their clients on the trading floor. Orders

are typically transmitted from private clients to registered commodity brokers through an introducing broker (*remisier*). In 1974, there were about 1,500 clients, including retail investors, and about 200 introducing brokers. Once a trade is completed, registered brokers are required to transmit the terms of the transaction to the clearinghouse. All futures contracts are for standardized quantities and qualities of commodities. In the sugar market, each contract bears on 50 tons of white sugar, with a maximum term of 16 months, and with five tradable maturities each year.

Until the collapse of the market at the end of 1974, sugar futures represent the largest segment of the Paris Commodity Exchange, in which cocoa and coffee futures are also traded. The governance and surveillance of the exchange are decentralized. A technical committee (*comité technique*), comprising both registered brokers and representatives of other market participants, ensures transactions take place according to the market's rule book. Finally, the Paris Chamber of Commerce is in charge of the overall surveillance of operations. The government's involvement is limited to one representative seating in several committees of the exchange.

### **3.2 The clearinghouse**

All trades in the Paris Commodity Exchange must be novated to a single central clearing party, the *Caisse de Liquidation des Affaires de Marchandises* (CLAM). Its functioning, depicted in Figure 1, closely resembles that of modern CCPs. The CLAM is a publicly listed company, whose only function is to clear and settle trades in the Paris commodity exchange. Its clearing members are all registered commodity brokers. The CLAM also opens clearing accounts for selected sugar professionals, typically large sugar dealers, and for one foreign CCP, the London-based International Commodities Clearing House. Any new transaction by an individual investor is registered at the CLAM in the name of its broker. The novation of a new transaction is complete once it is declared in identical terms by two brokers who are counterparties. After that, the clearinghouse bears all counterparty risk.

Counterparty risk is managed by the CLAM primarily through initial and variation

margins. Upon registration of a new transaction, both the buyer and the seller are subject to an initial margin requirement (*déposit*). The CLAM changes the level of initial margins over time, e.g., in response to changes in the level or volatility of prices, but its level is on average 10% of the notional value of the contract.<sup>4</sup> In addition to initial margins, each party commits to pay variation margins when prices move against it. Margin calls are computed based on an end-of-day settlement price set by the market’s technical committee. Variation margins must be received by the clearinghouse before the market re-opens on the second trading day after the call. If margins are not received, the positions are liquidated. In practice, the clearinghouse is legally registered as a bank, and each margin account opened for a broker is a standard deposit account. A broker deposits funds, which receive an interest, and can also benefit from external bank guarantees, such as letters of credit. Out of these funds, each broker pays initial and variation margins. Therefore, each clearing member’s balance with the CCP is defined as

$$\begin{aligned} \text{Balance on CCP account} = & \text{Deposited capital} + \text{External bank guarantees} \\ & - \text{Initial margins} - \text{Variation margins}, \end{aligned} \tag{1}$$

and a clearing member is considered in default as soon as its account balance becomes negative. However, in practice, the CLAM has often tolerated short-lived negative balances, due to operational delays associated with the payment of variation margins. In this case, initial margins temporarily cover a shortfall of variation margins.

To pay margins to the clearinghouse, registered brokers collect margin payments from their clients. In a typical arrangement, a client possesses a margin account with his broker, where deposited funds exceed the initial margin to be paid by the broker at the CCP. For example, if the initial margin required by the CCP is 10% of the contract value, the broker may require a deposit of 15% for its clients. The 5% buffer allows reducing the frequency of margin calls to investors. Importantly, clearing members are liable for the

---

<sup>4</sup>The CLAM is also allowed to vary initial margins for particular brokers, based on their risk characteristics or the size of their position. According to a confidential report produced by the Bank of France in 1975, this possibility was never used.

solvency of their clients, and therefore have to honor their commitments to the CCP even though some clients are unable to replenish their margin accounts when instructed to.

In case a member defaults, the CLAM takes all positions of the defaulting clearing member in its own name. It does not have a well-defined contractual default management scheme (“default waterfall”) in place. As such, it did not have the possibility to call additional margins from surviving members or to engage in contractual margin haircutting or tear-ups (see [Duffie, 2015](#), for a description). This implies that any loss made by the CLAM has to be absorbed through its equity.

### 3.3 The 1974 sugar crisis

We proceed with a description of the main features of the 1974 sugar crisis. A more detailed timeline of events is contained in Appendix Table [A1](#).

Between November 1973 and November 1974, global sugar prices have been multiplied by six, from 1,300 to 8,100 French francs (FRF) per ton, as illustrated in Figure [2](#).<sup>5</sup> The increase in sugar prices is due to a combination of structural and exceptional factors, which created widespread expectations of a physical sugar shortage.<sup>6</sup> In the Paris Commodity Exchange, price increases were accompanied by an inflow of funds from retail investors. Panel A of Figure [3](#) shows a boom in the number of new transactions registered by the CLAM between end-1971 and end-1974, from 54,000 tons traded per month, to 1.9 million tons per month. While sellers of sugar futures were mostly sugar producers and brokers, retail investors were taking long positions to an overwhelming extent. Using a breakdown of all brokers’ accounts at the CLAM into client sub-accounts, Table [1](#) shows that 96.9% of retail investors with an open position in December 1974 were holding a long position.<sup>7</sup>

---

<sup>5</sup>Throughout the paper, we report monetary amounts in 1974 FRF. 1 FRF in 1974 represents 0.76 EUR in 2015, i.e., approximately 0.85 USD in 2015.

<sup>6</sup>Structurally, highly volatile sugar prices in the 1970s can be explained by the limited share of the free sugar market (about 10% of global production), due to a large number of international agreements. In 1973 and 1974, prices of many commodities rose, following the oil shock. In the case of sugar, poor meteorological conditions and limits to exports by some countries (embargo in Poland) also contributed to the fear of a long-lasting sugar shortage. In 1974, several countries experienced shortages of sugar in grocery stores.

<sup>7</sup>Most accounts of the 1974 sugar crisis highlight that retail investors were not fully aware of the risks taken. Relatedly, we find 44 records of trials opposing investors to their brokers in 1974 and 1975. These

Starting on November 21st 1974, sugar prices started to fall. Two main factors led to major troubles at the CLAM and to the closure of the market on December 3rd. First, one registered broker, Nataf, was holding a large long position, representing 56% of the total open position by the CLAM.<sup>8</sup> This position was held on behalf of about 600 retail investors, not on Nataf's own account. As prices dropped, both Nataf and ultimate investors received large variation margin calls. Second, since the price on sugar futures hit the price fluctuation limit (called "limit down", see Appendix A) several days in a row, the market was not allowed to clear. While many investors were eager to unwind long positions to limit losses, their brokers could not find counterparties. Among others, Nataf could not execute orders from clients, which would have reduced its open position. Subsequently, a number of investors stopped responding to margin calls from Nataf or other brokers. Similarly, once it appeared that Nataf would fail on its variation margin calls, it was clear that the CLAM would not be able to immediately find counterparties to liquidate defaulted exposures and return to a matched book.<sup>9</sup>

Under the pressure of brokers with a long position, and with the support of the CLAM, the quotation of prices was suspended by government decision on December 3rd. After that, attempts to re-open the market did not succeed, in part due to the refusal of the CLAM to register new transactions before the settlement of outstanding positions was complete. The price at which existing positions should be settled was the main contentious issue. The market re-opened only in January 1976, after the liquidation of the CLAM and the creation of a new CCP, the *Banque Centrale de Compensation*.

---

trials involve 7 brokers, suggesting that debatable practices to attract investors were common. A novel by Georges Conchon and a movie by Jacques Rouffio, *Le sucre*, (1977 and 1978, respectively), describe these practices.

<sup>8</sup>There was no position limit at the clearinghouse. The Nataf position was built gradually, representing 9% of the total open position in January 1974, 20% in April, 42% in September and 32% in October. Furthermore, we highlight that while the status of registered broker can be given to individuals, such as Maurice Nataf, these individuals operate larger brokerage firms. When writing about Nataf, we consistently refer to the firm.

<sup>9</sup>Price fluctuation limits have subsequently been accused of amplifying the crisis by preventing the liquidation of defaulted positions. However, their effect remains theoretically unclear. Absent the limit, investors may have liquidated their contracts at a much lower equilibrium price, and may thus have defaulted on their cash payments (or margin calls) anyways.

## 4 Data

To study risk management incentives by the CLAM outside and around distress, we hand-collect data from two main archive centers: the Archives of the French Department of Commerce and the Archives of the Paris Chamber of Commerce. Both institutions were involved in the supervision of the Paris Commodity Exchange. Their archives contain a large number of documents related to the exchange, including legal documents and statistical records related to the activity of the market. We also obtain relevant documents from the Archives of the Bank of France and of the Ministry of Finance. Details on the archive sources are in Appendix B.

After the failure of the largest clearing member, Nataf, and the temporary closure of the sugar market, a large number of documents were collected by supervisors, including detailed data on the exposure of the CLAM, on the accounts of clearing members, and on transactions before the failure. Furthermore, a number of confidential reports were commissioned. We collect them, together with a large number of notes drafted by administrative staff for top officials. These documents allow us to reconstruct the history of the sugar crisis in great details. Importantly, a large body of documentation focuses particularly on Nataf, including detailed data on its account at the CLAM, on all initial and variation margin payments in the last three months of activity, and on all its transactions on behalf of retail investors in the last trading days. We also find a hand-written accounting book containing information on the financial position of all of Nataf’s clients.

Furthermore, we exploit the fact that the CLAM was a publicly listed firm, and collect daily data on its stock price, on dividend distributions and on the number of shares outstanding, for the 1966-1975 period. Data are obtained from the *Cours authentique et officiel*, the daily newspaper published by the professional association managing the Paris Stock Exchange. When there are no transactions on a given day, we instead use bids or asks (8% of observations). Data on the CLAM’s stock price are complemented with daily data on two stock market indices — one composite and one for financial firms only — computed by the Paris Stock Exchange. Relatedly, we also collect data on the ownership structure and governance of the CLAM from documents produced by the

banking regulator.

Finally, we reconstruct time series of spot and future sugar prices (by maturity) at a daily frequency. Data are obtained from the economic newspaper *Les Echos* for the 1973-1975 period. We obtain data on prices in the Paris market and in the other two global sugar markets, London and New York.

## 5 Risk management during the boom

We use our data to study CCP risk management both outside and around distress. In this section, we focus on risk management during the sugar price boom. We do not find evidence of lenient risk management during the year preceding the failure. Our findings are inconsistent with moral hazard being large.

### 5.1 Margins and exposures during the boom

Did initial margin requirements keep pace with sugar prices during the boom? Initial margins were set as a fixed FRF amount per ton of sugar traded, regardless of the maturity of the future contract, and was the same for buyers and sellers. A potential concern is therefore that, with a constant initial margin requirement, a rising sugar price would translate into lower risk controls for the CCP.

To answer this question, we collect information on all changes in initial margin requirements from end-1973 to end-1974. There are 12 such changes, plotted in Panel A of Figure 4. With the exception of a short-lived peak in January 1974, initial margins have been increasing over the period, from 140 FRF per ton of sugar in December 1973 to 800 FRF per ton in November 1974.<sup>10</sup> To assess whether this change is commensurate to

---

<sup>10</sup> The January 1974 peak in margins follows a large increase in sugar prices. After that, many investors closed their long positions to cash in their gains and buy futures at the new price (so-called *achetés-vendus*). Therefore, the CLAM had to disburse cash to these investors. Since a sizable part of variation margins for investors with short positions were not paid in cash but with bank guarantees, the CLAM was faced with a liquidity shortage. The increase in margins was decided to make it more costly for investors to open new positions and induce them to keep their existing positions until maturity. The increase in margin requirements reduced trading volume (see Panel A of Figure 3) and was reverted a few days later.



changes in future prices over the period, we normalize initial margin requirements by the settlement price on the nearest-term future on every trading day. The results, plotted in Panel B of Figure 4, show that initial margin requirements have been remarkably stable during the sugar price boom, representing about 10% of the nearest-term future price. This is still true within the last few weeks of operations, when the CLAM was larger in size and could in theory have been more subject to moral hazard. This first piece of evidence is inconsistent with the idea that the failure of the CLAM is due to a lenient management of initial margins during the boom.

A related concern is that initial margins did not keep up with a possibly increasing volatility of sugar prices. We compute volatility as the standard deviation (denoted  $\sigma$ ) of log changes in sugar prices over the past 30 trading days,

$$\text{Vol}_t = \sigma(\ln p_{t-s} - \ln p_{t-s-1}), \quad s \in \{0, \dots, 29\}. \quad (2)$$

This volatility of the nearest-term future sugar price is plotted in the Appendix Figure A2 over the year 1974. While volatility increased in October and November 1974, it was not markedly higher than its historical level. In particular, it had reached higher levels for several months in the first quarter of 1974.

Since initial margins scaled with sugar prices, one may wonder whether a level of initial margins of 10% is itself too low on a permanent basis. Several elements suggest that this is unlikely. Indeed, this level of margins is markedly higher than the one that prevailed in London (2% of the sugar price), while sugar prices closely tracked each other across markets. Furthermore, initial margins at the CLAM were paid based on the largest gross exposure. For example, an investor with a long position of 5 contracts and a short position of 3 contracts would pay margins based on 5 contracts. In contrast, margins in London were paid on the net exposure. Therefore, in this example, the investor would pay margins based on  $5 - 3 = 2$  contracts only. Lastly, we highlight for comparison that the level of initial margins collected by the CLAM in 1974 was markedly higher than initial margin requirements currently being imposed on similar future contracts. For example, in October 2016, margin requirements set by ICE on US sugar futures represented about

6% of the price of sugar. Taken together, all these arguments cast doubt on the idea that margins requirements were structurally too low in the Paris Commodity Exchange.

A last concern about margins could be that, while the quantity of initial margins required scaled with changes in the level and volatility of prices, the quality of margins deteriorated. In particular, the use of bank guarantees was widespread to meet margins over that period. Since bank guarantees do not represent actual cash inflows for the CCP, but off-balance sheet assets, they were considered of lower quality. To assess whether the quality of margins posted decreased, we find daily data on the margin account held by Nataf at the CLAM in the three months preceding its default. The decomposition of assets on its margin account, and of its margin calls, is plotted in Panel A of Figure 6. While bank guarantees represented a large share (56.9%) of total margins in September 1974, it is noticeable that subsequent margin calls were paid almost exclusively in cash. By the end of November, the ratio of bank guarantees to total margins fell to 32.2%. Therefore, there was no decrease, but an increase, in the quality of margins posted by the largest clearing member. Moreover, the CLAM was verifying the quality of bank guarantees, and there is evidence that it refused letters of credit from banks that were not creditworthy enough (see Appendix A for an example in the fall 1974). This further challenges the idea that poor risk management during the boom is to blame for the failure of the CLAM.

Finally, two additional pieces of evidence are worth noting. As seen in Appendix Figure A1, the open position of the CLAM measured in tons of sugar had been continuously decreasing since mid-1973. Therefore, the increase in exposure (in both Panels A and B) was entirely due to changes in prices, a factor which is beyond the control of the CLAM. Moreover, we highlight that, while we find numerous supervisory reports from the Bank of France and the Chamber of Commerce written in 1974, none of them expresses major concerns related to risk management deficiencies at the CLAM before the crisis.

## 5.2 Event studies using margin changes

We proceed with a study of the pricing by equity holders of the CLAM’s decisions regarding risk management. We exploit a unique feature of the CLAM, which is that it is publicly listed in the Paris Stock Exchange. Event studies around changes in initial margin requirements allow assessing whether the equity structure favors prudent risk management.

Since there are no previous studies of a CCP’s market value, we briefly describe the dynamics of the CLAM’s stock price, plotted in Figure 5 over the 1966-1975 period. After several years of stability, the large increase in the CLAM’s stock price coincides with the increase in trading volume that starts in 1972 and continues in 1973 (see Figure 3). Indeed, the CLAM generates a large part of its income from clearing fees, which do not depend on sugar prices. During the main phase of the sugar price boom (i.e., the year 1974 until end-November, see Figure 2), the stock price of the CLAM did not increase overall. However, since the market performed poorly in 1974 (see Figure A3), the stock of the CLAM is earning large excess returns. Finally, the CLAM’s stock price did not start to collapse when sugar prices dropped, but only when Nataf was declared in default and the sugar market closed.

We use stock market data to conduct event studies around all increases in initial margin requirements in 1974. In theory, there is a trade-off from the perspective of equity holders. Higher margins have a negative impact on trading volume, thus reduce clearing fees.<sup>11</sup> However, additional margins also reduce the risk of CCP default. Which of these effects is most highly valued by shareholders is a priori unclear. For a CCP subject to significant moral hazard, theory predicts that it is more likely to keep margins at a low level, in order to generate high trading volume, with the expectation of a bail out when its risk management fails in bad aggregate states.

There are nine distinct increases in initial margins over our sample period, as shown in

---

<sup>11</sup>In theory, higher margin requirements may increase trading volume if counterparty risk or information asymmetries prevent gains from trade to be exploited. In futures markets where a CCP is operating, empirical evidence consistently shows a negative relation between margin requirements and trading volume or open exposures (Hardouvelis and Peristiani, 1992; Hardouvelis and Kim, 1995). We observe a similar relation in our context.

Panel A of Figure 4. In the baseline specification, we exclude the large increase in margins of end-January 1974, which was decided for reasons other than standard risk management (see footnote 10). However, we show that our results are robust to including this event. We center our event studies around the implementation date of margin increases, denoted  $\tau$ , and focus on an event window of five trading days before and after the event. A potential concern is that the implementation date is not the same as the announcement date, which we do not observe, and which should be more directly relevant for the stock price. However, this concern is minor in our case. First, according to the rule book of the CLAM (CLAM, 1971, Article 10), new margins requirements are effective at most two days after they have been announced, unless a government representative opposes the decision. There never was any such opposition over our sample period. Second, for two out of eight events, we find original documents confirming that new margining rules are immediately enforced after they are disclosed. In this case, the implementation date and the announcement dates are exactly the same. In contrast, we do not find any document providing evidence of delays in the implementation of margining rules. Therefore, immediate enforcement may have been common practice. Finally, as shown below, there is no evidence of pre-implementation trends which would suggest that the announcement date precedes the implementation date.

We estimate abnormal returns  $AR_{it}$  for any date  $t$  and event  $i$  using a one-factor market model,

$$AR_{it} = R_{it} - \hat{R}_{it} \quad \text{where} \quad \hat{R}_{it} = \hat{\alpha}_i + \hat{\beta}_i R_{mt}. \quad (3)$$

In Equation (3),  $R_{mt}$  is the market return at date  $t$ ,  $R_{it}$  is the realized return on the stock of the CLAM at  $t$  around event  $i$ , and  $\hat{R}_{it}$  is the predicted value of  $R_{it}$ , as obtained from a one-factor market model.  $\hat{\alpha}_i$  and  $\hat{\beta}_i$  are estimated for each  $i$  on a window of 300 trading days preceding, but not including, the event window. Our object of interest is the cumulative abnormal return  $C\bar{A}R(\tau - 5, \bar{\tau})$ , starting at the beginning of the event window ( $\tau - 5$ ) and running until each date  $\bar{\tau} \in [\tau - 5, \dots, \tau + 5]$ , averaged over all  $N$

events,

$$C\bar{A}R(\tau - 5, \bar{\tau}) = \sum_{t=\tau-5}^{\bar{\tau}} \left( \frac{1}{N} \sum_{i=1}^N AR_{it} \right). \quad (4)$$

We compute confidence intervals using formulas in [MacKinlay \(1997\)](#).

Estimates for the baseline model are collected in Panel A of [Table 2](#), and average cumulative abnormal returns are plotted in [Figure 7](#). Cumulative abnormal returns are not significantly different from zero before the event, but become positive and significant after initial margin requirements increase. Five days after the event, the cumulative abnormal return equals 2.3% and is significant at a 1% level, in spite of a relatively small number of events. These estimation results show that equity holders were reacting positively to decisions which contribute to more stringent risk management. This is remarkable, since most of our events of interest are concentrated in the weeks preceding the CLAM’s failure, where moral hazard could in theory have been larger. Indeed, the CCP was larger in size, as measured both by the volume of operations cleared ([Figure 3](#)) and by the market value of its open position ([Figure A1](#)).

This result is robust to alternative specifications, as we show in Panel B. First, it is robust to including the large increase in margins decided in January 1974 ([Column 1](#)). Another potential concern is that abnormal returns are incorrectly estimated since, for a given event, the estimation window includes the stock price around previous events. To address this concern, we estimate a unique market model in the 300 days prior to the first event, during which there was no change in margin requirements, and find similar results ([Column 2](#)). We also check that our results hold when estimating abnormal returns using a 2-factor model, where the second factor is an index of returns on financial firms ([Column 3](#)). Finally, since our estimation relies on a small number of events, we check in unreported regressions that the results are not driven by one particular event. Our results are robust to the exclusion of each particular event.

One last potential concern pertains to the interpretation of the results. Since equity holders should react to the announcement of more stringent risk management, it might be expected that the stock price jumps on the event day. Instead, our estimates suggest an incorporation of the news within the stock price over several days. A likely explanation is

that the liquidity of the stock was limited, so that the speed at which information could be incorporated into prices was reduced. Indeed, the CLAM's shares were registered shares, which are more costly to trade. Furthermore, a significant fraction of the equity base was held by blockholders who did not trade on a day-to-day basis (see Appendix Table A2).

Overall, all results in this section show that there was no markedly weaker risk management during the sugar price boom. Therefore, it suggests that the CLAM was not significantly affected by moral hazard. One potential explanation is that the CLAM did not benefit from explicit or implicit bailout guarantees, even though it was a monopolist (by law) and had been quickly growing in size. Our findings also highlight that a CCP failure does not necessarily follow a sustained period of lenient management, but can affect robust institutions due to large price changes.

## 6 Risk management incentives before default

We turn to a study of risk management by the CLAM around default. In this section, we focus on risk management incentives during the collapse of sugar prices (starting on November 21st), but before Nataf is declared in default and the market closes (December 2nd and 3rd, respectively). We find that it is only when sugar prices started to fall and Nataf's balance turned negative that incentives by the CLAM became severely distorted.

### 6.1 Risk management before the market closure

During the boom, no clearing member was faced with major difficulties to pay variation margins, even though margin calls were large for sellers of sugar futures.<sup>12</sup> The situation changed when prices started to fall. In particular, the balance on Nataf's account at the CLAM became negative after a few days, and that of other brokers was close to zero. This was due to unusual changes in prices: between November 21st and December 2nd, the limit-down (set at 300 FRF per day, see Appendix A) was hit seven times and sugar

---

<sup>12</sup>The main explanation is that most sellers of sugar futures were sugar producers or dealers, who were simultaneously benefiting from high spot prices.

prices fell by 21%. The trading volume was low, since the market does not clear at the limit down price. At that point, several pieces of evidence show distortions in the CLAM's risk management.

Panel B of Figure 6 plots Nataf's account balance at the CLAM, computed as in Equation (1), in the last three months before it defaulted. After prices started to fall, Nataf's balance turned negative on November 25th. Nataf was not declared in default on that day, but received variation margin calls. As discussed in Section 3, it was usual for the CLAM to consider that initial margins could cover temporary shortfalls in variation margins, when these shortfalls were due to operational reasons, such as postal delays.<sup>13</sup> Such shortfalls were often benign and paid for quickly. Example are given by Nataf itself, since Figure 6 shows shortfalls early in September 1974 and two times in November. These shortfalls should not be interpreted as early signs of weakness by Nataf since they were paid for quickly. Furthermore, as the market supervisor notes in an inspection report, "Nataf paid margins as no other broker before him did, covering not only variation margins with cash, but also a large part of initial margins and, for certain days, all initial margins or more". Therefore, until November 25th, the CLAM could have been thinking that the shortfall (2 million FRF) was not unusual, since initial margins paid by Nataf were still far larger (74 million FRF).

However, as sugar prices continued to collapse, the CLAM took two decisions that led to its failure. It started by delaying the declaration of Nataf's default to the professional association of registered brokers. It should have been clear for the CLAM that the shortfall on Nataf's account was not due to operational delays, but to exceptional price changes. Therefore, the shortfall should not have been treated as usual payment delays, even though Nataf managed to bring additional cash and bank guarantees for an amount of 21 million FRF between November 27th and December 1st. Precisely, the CLAM waited until Nataf's shortfall was larger than its initial margin to declare its default, which occurred on December 2nd, as Figure 6 shows. The decision to delay the declaration of default was misguided, since on the day default was declared, there was no more initial

---

<sup>13</sup>A strike of postal and telecommunications services in November 1974 made it difficult for registered brokers to collect margin payments from their clients.

margin left to bear the cost associated with the liquidation of Nataf’s position. A direct consequence of delaying the declaration of Nataf’s default is a delay in the liquidation of its defaulted position, amid falling sugar prices. While it is unlikely that the CLAM could have liquidated all of Nataf’s position (56% of the total open position) within a few days, due to several consecutive limit downs, it could have eliminated some of it. In particular, the limit down was not reached on November 27th. Therefore, part of the position could also have been unwound in Paris or hedged in London and New York, where there was also limited trading volume despite limit downs.

Moreover, the CLAM continued to register trades executed by Nataf during the period in which its account balance was negative. Registering these transactions was in contradiction with the CLAM’s rule book (CLAM, 1971, Article 18), and can be seen as an additional distortion. From data on all trades executed by Nataf either in the name of its clients or in its own name, we see that, after its account balance became negative, Nataf was unwinding positions. Starting on November 25th and until its default, Nataf reduced his position by 34 million FRF (representing about 6% of its position on the day of default). Therefore, trading patterns by Nataf may partly explain why the CLAM continued to register new transactions, even though it violated its own rule book. This decision, together with delays in declaring default suggest that the CLAM was acting to protect Nataf. In Section 7.2, we show that the full set of misguided decisions taken by the CLAM can be understood as a form of risk-shifting.

## 6.2 Distorted incentives for brokers

We complement our analysis by providing evidence of incentive distortions affecting registered brokers. When there are no major concerns about the default of the clearinghouse or of ultimate investors, brokers should be indifferent about the execution price that each investor obtains, since they primarily act as intermediaries. Instead, when some investors are more likely to default, either because their balance is closer to zero or the size of their position is larger, brokers may have an incentive to execute trades at prices that favor these investors, at the expense of other investors. If this is the case, investors closer to



default get reduced margin calls, at the expense of solvent investors who can still pay margins.

To show evidence of such distortions, we use a record of all transactions executed by Nataf after sugar prices started to fall. These data include the name of the counterparty, the volume and maturity of each transaction, as well as the execution price. There are 314 such trades, for 67 investors. Based on family names, we match these transaction data with data on the open position of each investor as of Dec. 2nd, and with data on the account balance of each investor. This second dataset, collected by the Department of Commerce after the market closure, allows computing the average price at which investors bought or sold outstanding contracts.

For a trade  $j$  executed on behalf of investor  $i$  at date  $t$  and with future maturity  $m$ , we estimate

$$\text{Exec. price}_{i,j,m,t} = \beta_0 \cdot \text{Exposure}_{i,t} + \beta_1 \cdot \text{Volume}_{i,j,m,t} + FE_m + FE_t + \epsilon_{i,j,m,t}, \quad (5)$$

where *Exec. price* is the execution price of the trade and *Exposure* is a measure of investor  $i$ 's exposure to the price collapse. *Volume* controls for the size of each trade, expressed in number of tons. Finally, maturity and day fixed effects ( $FE_m$  and  $FE_t$ ) are included, to isolate price dispersion within a given day and contract maturity.

We estimate Equation (5) separately for buy and sell transactions. We use two measures of investor exposure. First, the average execution price for the existing position of each trader. For an investor with a long position, a high average execution price for existing trades means that his account balance is turning negative more quickly when sugar prices drop. Second, we use the size of an investor's existing position, expressed in number of contracts, as an additional measure of exposure. We do so because initial margin calls scale with the size of positions. If brokers distort execution prices to favor clients that are closer to distress, we expect higher measures of investor exposure to be associated with lower execution prices for buy orders and with higher execution prices for sell orders.

Estimates are collected in Table 3. Panel A, focusing on buy orders, shows consistent

evidence of distortions in execution prices. Investors which are more exposed to the collapse in sugar prices are given significantly cheaper execution prices when buying sugar futures. This is true regardless of the variable used to measure exposure, and suggests that Nataf had incentives to help investors closer to distress. Evidence for sell orders, in Panel B, is consistent with the existence of distortions, since investors with a large exposure are given higher execution prices when selling. However, the corresponding coefficient estimates are not statistically significant. There can be two reasons why results are weaker for sell orders. First, since sell orders correspond to investors liquidating their positions, the concern that they may default on their margin calls in the future is presumably smaller, so that incentives to distort execution prices are lower than for buy orders. Second, the number of observations for sell orders is smaller, so that tests may lack statistical power. Despite weaker results on sell orders, we interpret results in this section as being consistent with the existence of distorted incentives for dealers near distress. These distortions stem from the fact that some investors may default on their margin calls, giving brokers incentives to manipulate execution prices in their favor, at the expense of solvent investors.

We highlight two mechanisms through which this effect can work. One explanation is that there is some collusion between registered brokers to execute trades favoring investors near default, at the expense of other investors. We do not find anecdotal evidence supporting this idea. Another explanation follows from the fact that all trades within a given day were typically registered at the CLAM only at the end of the day. This practice allowed reshuffling counterparties across trades before novation, to favor certain counterparties at the expense of others. This alternative explanation finds support in anecdotal evidence collected by supervisors, but was never systematically studied.<sup>14</sup>

---

<sup>14</sup>As a consequence of these concerns, the rules of the exchange after its re-opening in 1976 mandated the immediate registration of new trades with the clearinghouse.

## 7 Risk management after the market closure

Following Nataf's default, the closure of the market and the failure to agree on a recovery plan are also evidence of distorted incentives by the CLAM. We show that these distortions can be jointly understood as a form of risk-shifting.

### 7.1 Closure of the market and recovery plans

After Nataf is declared in default on December 2nd, other clearing members with long positions are also close to default. On the next day, another fall of sugar prices to the limit down would have induced the default of two additional members, while a collapse of prices over a longer period would have threatened up to 8 or 10 members. Since the CLAM is designed to take the entire position of defaulted members, it would have had extremely large exposures to liquidate. Limit downs on sugar prices in Paris, but also in London and New York, implied that it could not quickly sell or hedge this open position either domestically or abroad. In this context, both the CLAM and the professional association of registered brokers decided to push for the suspension of trading in the sugar market.<sup>15</sup> On December 3rd, they both exercised pressure on the Minister of Commerce, who authorized a temporary closure of the market.

The decision to ask for the closure the market is evidence that the CLAM was close to default. We interpret it as a gamble for resurrection, due to a particular feature of the sugar market's rule book. According to Article 22 of the rule book, if trading is suspended due to exceptional circumstances (such as a war), the technical committee sets a price for the immediate settlement of outstanding positions, which equals the average of prices prevailing in the last 20 trading days. In this case, the price mandated by Article 22 was around 7,400 FRF per ton, i.e., about 1,200 FRF (or 20%) above the settlement price on December 2nd. At that settlement price, Nataf would have a positive account balance, and therefore would not default (and actually make substantial gains). Consequently,

---

<sup>15</sup>In theory, the professional association of registered brokers should not favor one type of counterparty against another. However, the association was largely controlled by brokers with long positions. The brokerage firm run by the president of the association, Georges Maurer, had the second largest long position in sugar futures, after Nataf.

the CLAM would not default either. However, the bet on Article 22 was risky, since its applicability was highly debatable. Indeed, no extraneous reason prevented the market from functioning.<sup>16</sup> The push for Article 22 can therefore be seen as an attempt to manipulate the settlement price. Below, we show more precisely that this decision by the CLAM is akin to risk-shifting.

After the closure of the market, the main issue for the CLAM and all other parties was to find a settlement price for outstanding positions. First, several lawsuits took place, in which judges were asked whether the closure of the market was legal, and thus whether Article 22 should apply for the settlement of existing positions. Second, and in parallel, there were a number of attempts to negotiate a recovery, initiated mostly by sugar professionals. The president of the market's technical committee, Maurice Varsano, also the head of a large sugar dealing firm (*Sucre et Denrées*, which had a short position), refused the implementation of Article 22, so that no settlement price was fixed. However, Varsano proposed that sugar professionals buy the defaulted exposure of Nataf, and eventually that of other brokers in distress, at the settlement price on December 2nd, 6,217 FRF. One of the biggest mistakes made by the CLAM was probably to refuse the proposal, which would have impaired its equity, but which would have avoided its default and made possible a quick reopening of the market. Instead, the CLAM was confident that Article 22 would apply, in which case its equity would not have been impaired at all. In the next few weeks, global sugar prices continued to fall (see Panel B of Figure 2), so that sugar sellers revised their offer. Until the resolution came to an end, they maintained an offer to buy the defaulted position of Nataf, and eventually that of other brokers, at a price of 5,700 FRF, even after prices fell far below 5,700 FRF. This came to be known as the "Varsano proposal". Even though the proposal would have accelerated a reopening of the market, it was never accepted.

The decision of the CLAM to support the closure of the market and to push for the implementation of Article 22 illustrates one of the main distortions that can arise for a

---

<sup>16</sup>Article 22 mentioned "general mobilization in case of war and cases of force majeure, among others" as potential reasons for closure. Furthermore, it was known that in 1933-1935, the Council of State had invalidated a similar decision in the cereal futures market (Simon, 1981).

CCP around distress. Indeed, while a CCP with a matched book should be indifferent to the settlement price and to the distribution of margin calls among clearing members, this is no longer true near default. The push for Article 22 can be seen as an attempt to manipulate the settlement price, in order to tilt margin calls towards sugar sellers, and in favor of sugar buyers, including primarily the defaulting member. Similar incentives are likely to be a more general features of CCPs near distress, as soon as initial margins and default fund contributions are not sufficient to cover shortfalls from the defaulted member, so that the CCP's equity is a risk.

## 7.2 Risk-shifting incentives

In this section, we show that distortions in risk management incentives both before and after the closure of the market can be understood as risk-shifting. Risk-shifting arises near distress due to a convexity in the equity value function: since equity holders' payoffs are bounded below by zero, they have no incentive to take actions that reduce the probability of low outcomes; instead, their expected payoff increases if they take risky actions that yield large payoffs in good states ([Jensen and Meckling, 1976](#); [Leland, 1998](#)). We show that, in the week preceding the closure of the market, the CLAM was precisely in the region where its equity value function is convex.

In [Figure 8](#), we use data on the CLAM's exposure to registered brokers to plot the market value of its equity as a function of the settlement price for outstanding positions. As discussed in [Section 2](#), a CCP that is far from distress is indifferent to the settlement price of transactions, due to its matched book. This feature of a CCP capital structure appears for settlement prices above 6,300 FRF per ton. Below this threshold, Nataf defaults and the CLAM is unlikely to recover any additional margin it calls. In this region, any additional loss is absorbed by the CLAM through an impairment of its equity. This is a direct consequence of the fact that the CLAM did not have a contractual default waterfall in place (unlike most modern CCPs, see [Duffie, 2015](#)), in which case part of the loss would have been shared with surviving members. For example, with a default waterfall, the CLAM could have been contractually haircutting initial or variation margin

gains, or calling extra contributions. The absence of default waterfall is key to understand the magnitude of risk-shifting incentives for the CLAM.

Figure 8 also shows that, at the settlement price on December 2nd, close to 6,200 FRF, the CLAM is making a loss of 8.1 million FRF, which its equity (31.8 million FRF) can absorb. In spite of the fact that this price was a limit down price, a liquidation of Nataf's exposure at these conditions could still have been possible, due to the first proposal made by Varsano (see Section 7.1). Governance problems can explain why the CLAM refused this proposal, as discussed in the next section. For any settlement or liquidation price lower than 6,200 FRF, the CLAM's equity value is decreasing quickly. In case the settlement price is below 5,900 FRF, the market value of the CLAM's equity falls to zero. This can easily explain why the CLAM subsequently refused the Varsano proposal at 5,700 FRF, which could have allowed the market to re-open. After it failed to accept a first compromise at a price of 6,217 FRF, and sugar sellers were determined to impose a settlement price of 5,700 FRF, it became clear that betting on Article 22 was the most profitable strategy. To understand the distortions of incentives, it is therefore important to stress that the CLAM was, on December 2nd, in the region where its equity value is convex. The first judicial decision by the Paris Commercial Court (on December 11th) reinforced the CLAM's view that betting on Article 22 could be a profitable strategy, since it confirmed that the closure of the market was legal.

An alternative strategy to risk-shifting could have been a negotiated recovery, i.e., a multilateral agreement on a settlement price for Nataf's exposure that both the CLAM and sugar sellers could accept. While Figure 8 makes it clear that the Varsano proposal could not be accepted by the CLAM, it also highlights that the market value of the CLAM's equity was extremely sensitive to minor changes in settlement prices. Indeed, for prices below 6,300 FRF, any drop in the settlement price by 100 FRF wipes out 25.5% of the CLAM's equity. In a single trading day when prices fall to the limit down (set at 300 FRF per day at that point in time), 76.4% of the CLAM's equity can be impaired. Therefore, provided that sellers are not willing to forego all of their gains, the range of prices in which a recovery can be negotiated is narrow. This can explain why a negotiated

recovery ultimately failed to be agreed upon.

We stress that similar risk-shifting problems are likely to be a more general feature of CCPs, and are possibly more acute than for other types of financial institutions or firms, due to the limited amount of equity that most CCPs hold relative to their largest potential clearing obligations. Similarly, the limited set of feasible recovery strategies is likely to characterize CCPs more broadly. We discuss policy implications of these facts in Section 8, and also highlight that the design of CCP default waterfalls may significantly mitigate risk-shifting incentives.

### 7.3 Governance structure of the CLAM

The governance structure of the CLAM may have exacerbated risk-shifting incentives. The existence of delays to liquidate Nataf’s position suggests that the CLAM was given too much discretion and that its decisions were not sufficiently based on rules. Governance is also essential to understand why the CLAM refused the first offer by Varsano to buy the defaulted exposure of Nataf at the settlement price prevailing on December 2nd. At this price, the CLAM would have been making a loss (see Figure 8), but would have remained far from default, and the market could have re-opened. A potential reason why the CLAM did not accept this offer is that the two stakeholders most attached to the continuation of clearing services — large shareholders and sugar professionals — were poorly represented among the board and managers of the CLAM.

First, the board of the CLAM did not primarily represent the interests of its equity holders, including large shareholders. For example, there was no representative of the insurance company *AGF* on the CLAM’s board, even though it was a majority shareholder (see Appendix A for details on the board composition and Appendix Table A2 for details on blockholders). Given evidence showing that large shareholders tend to be more conservative (see for example Faccio, Marchina, and Mura, 2011), it is likely that a better representation of them within the board of the CLAM could have alleviated risk-shifting incentives.

Second, while the board of the CLAM was composed of representatives of both regis-

tered brokers and sugar professionals, it was in practice dominated by registered brokers. In particular, the President of the CLAM, Gérard Bauche, was a former broker, whose own brokerage firm was still operating, with a long (albeit small) position in sugar futures. This governance structure implied that sugar professionals, who attach the largest value to the continuation of clearing services, due to hedging needs, had relatively little weight on decisions. In this context, we can hypothesize that a member-owned CCPs, by better accounting for the diversity of views among members, could have had lower risk-shifting incentives. In this respect, the situation faced by the CLAM was similar to that described by [Franks and Nyborg \(1996\)](#), where inefficient liquidations arise if control rights are not given to creditors with the largest benefit from keeping the firm as a going concern.

## 7.4 The resolution of the CLAM

We conclude with a brief description of the resolution of the CLAM. For several months, it was unclear whether the crisis would end with a recovery of the CLAM or with its resolution. The initial goal of all parties was a recovery, as a wealth of documents indicate. Also supporting the idea that the CLAM would recover is the fact, shown in Panel B of [Figure 3](#), that it continued to register and clear contracts on cocoa and coffee after the closure of the sugar market. Volumes in these markets did not significantly drop, even though margins for contracts on cocoa and coffee were not segregated from margins on sugar futures.

The shift from a tentative recovery to a resolution plan occurred in June 1975. After a series of legal procedures, described in [Appendix Table A1](#), the initial decision of the minister of commerce to close the market was invalidated by the Council of State. This implied that positions could not be settled based on Article 22, and therefore that the CLAM would not have sufficient equity to absorb losses under any plausible scenario. After that, an administrator was appointed by the government, in order to find an agreement on a settlement price and on a plan to share additional losses. We highlight three features of the resolution plan, which was approved by all parties in December 1975. Additional details on the allocation of losses are postponed to [Appendix Table A3](#).



A first feature of the resolution plan is that it partially resembles variation margin gains haircutting, currently at the center of discussions on CCP resolution (see, for example, [Duffie, 2015](#)), and which consists in reducing or canceling variation margin payments to parties making gains. According to the final agreement, the positions of sugar future sellers are settled at a price of 6,017 FRF, i.e., 200 FRF below the price prevailing on December 2nd. At the time the plan was agreed upon, sugar prices had been further falling to about 1,500 FRF per ton. Therefore, sellers forego a large part of the gains they were entitled to. In contrast, the positions of sugar future buyers are settled at a price of 6,317 FRF, i.e., 100 FRF above the price prevailing on December 2nd, which enables them to limit losses. For this arrangement to be feasible, however, about 200 million FRF had to be found, both from the liquidation of the CLAM's assets, and from other sources.

A second feature of the resolution plan is that, among the funds needed for the agreement, 15 million FRF were paid for directly by the professional associations of sugar producers and of beet producers. The contribution of sugar professionals is therefore not limited to foregoing large gains on their positions, which indicates that they attach high value to the continuation of clearing services, and therefore to a quick resolution of the crisis. In addition, starting with the “Varsano proposal” in December 1974 (see [Section 7.1](#)) and throughout 1975, several documents show that sugar professionals were the most eager to resolve the crisis and re-open the market, due to hedging needs. By showing that counterparties with an interest in hedging attach more value to the continuation of clearing services, this fact suggests that a fully member-owned CCP could have been better run around distress.

As a last part of the resolution plan, all assets of the CLAM have been liquidated, for about 150 million FRF. The shareholders of the CLAM, being residual claimants, have been losing most of the value of their equity stake. Panel B of [Figure 5](#) shows that the CLAM's stock price has been falling almost continuously after the closure of the market. As part of the resolution plan, the CLAM brought all its assets. Large equity holders (banks and insurers) sold their shares for 1 FRF per share, while small equity holders sold for 100 FRF per share. A unique firm acquired all shares, in order to set up the

successor CCP. We highlight that there was no direct cost incurred by the government. However, since the majority shareholder (*AGF*) and two other shareholder banks (*Crédit Lyonnais* and *Société Générale*) were government-owned companies in 1974-1975, there was an indirect cost born by taxpayers. In spite of government-owned firms being involved as shareholders, the absence of any additional government contribution is consistent with the fact that we do not find evidence of significant moral hazard ex ante.

A natural question is whether the re-opening of the sugar market, more than a year after its closure, could have been accelerated if an administered resolution plan had been implemented earlier, instead of seeking a recovery of the CLAM. Similarly, [Duffie \(2015\)](#) argues that a key question when a CCP fails pertains to when a resolution process should override contractual default management processes. Our analysis of risk-shifting in [Section 7.2](#) suggests that the set of profitable recovery or renegotiation plans can be limited in case of CCP failure. Indeed, as [Figure 8](#) illustrates, the sensitivity of the CLAM's equity value to the settlement price is high after the market closes: for any drop in the settlement price by 100 FRF, the CLAM loses about one-fourth of its equity. This implies that there is only a limited range of settlement prices that the CLAM can accept without taking a loss that exceeds the value of its equity, unless parties with variation margin gains agree to forego them. In the case of the CLAM, while sellers of sugar futures were willing to accept a settlement price above market prices after the market closed (the Varsano proposal), they were not willing to forego all gains either, by accepting a settlement price of 6,200 FRF or above. On the other side, the CLAM could not accept a settlement price below 5,900 FRF, which would have driven its equity below zero. Therefore, the scope for negotiating a recovery was extremely limited, which can explain why no recovery was ultimately agreed upon. We hypothesize that the relatively limited scope for renegotiation and recovery (without government assistance) is a more general feature of CCPs in distress, due to the fact that they operate with low equity, so that their equity value becomes highly sensitive to settlement prices around default.

## 8 Conclusion and policy implications

We conduct the first empirical study of the failure of a CCP. We do not find evidence of lenient risk management during the sugar price boom of 1974, suggesting that the CLAM was not faced with significant moral hazard. Yet, we document a number of severe distortions as soon as sugar prices collapsed and a large clearing member approached default, as well as during the recovery/resolution phase. We interpret these distortions as being akin to risk-shifting. We conclude that major disruptions of clearing institutions can occur even in the absence of moral hazard. Based on our results, one can draw several policy implications.

Policy should not only aim at addressing the effects of moral hazard, even though moral hazard is arguably larger today than during the period we study, due to the fact that CCPs have become larger and that clearing is now mandatory for many securities. Instead, we stress that the risk-shifting problem we identify is likely to be a more general concern for CCPs. Indeed, as highlighted by [Duffie \(2015\)](#), most, if not all, CCPs operate with small amounts of equity relative to their largest potential clearing obligations. Therefore, conditional on a large member being in default, it is likely that any CCP is faced with the problem that its equity value becomes highly sensitive to relatively small changes in settlement or liquidation prices. One potential implication is that CCP equity should be higher, since higher equity reduces the set of profitable risk-shifting strategies.

However, in contexts where CCPs clear large exposures, and where members hold large open positions, it is unlikely that CCPs can operate with equity levels that completely rule out risk shifting. As we show, conditional on a large member being in default, the sensitivity of a CCP's equity value to settlement prices can be large. Equity levels that could eliminate risk-shifting are possibly orders of magnitude higher than current levels. Therefore, other instruments that can prevent risk-shifting near default are valuable. In this respect, the governance structure of CCPs is important to consider. Member-owned CCPs are likely to have better incentives, since their private valuation for the continuation of clearing services is arguably higher than that of for-profit CCPs. Furthermore, better governed CCPs are possibly given less discretion with respect to rules, a feature which can

be valuable given the experience of the CLAM. However, research on the ownership and governance of CCPs is scarce, and we leave a more detailed discussion of these questions for future research.

Finally, our results have implications for the design of CCP default waterfalls. Our discussion of risk-shifting relied importantly on the fact that, in the absence of pre-specified procedure to call extra resources from solvent members, equity holders were the unique residual claimants during distress. Instead, default waterfalls of many modern CCPs are such that only part of their equity is impaired before additional resources are called from members (e.g., replenishment of the default fund), or losses are directly imposed onto members (e.g., in case of contract tear-ups, see [Duffie, 2015](#)), before additional equity is impaired. In this case, equity holders are not the only residual claimants or financiers, but share this role with CCP members — either fully or until some pre-specified limit. Clearly, this is true only if extra resources can be raised quickly from surviving members, which is not warranted in the midst of major financial turmoil. While the structure of default waterfalls with multiple tranches of equity is usually seen as a way to give CCP equity holders skin-in-the-game, we highlight that it can also be valuable to mitigate risk-shifting incentives. Indeed, this structure reduces the sensitivity of a CCP’s equity value to settlement prices near default, which we identify as an important driver of risk-shifting incentives. As we highlight, reducing this sensitivity can also be a way to enlarge the set of ex post profitable renegotiation and recovery strategies, and reduce the probability that a failed CCP is resolved. However, our study is silent on how exactly the tranching of a CCP’s equity within its default waterfall should be designed. We leave this important question for future work.

## References

- Acharya, V. and A. Bisin (2014). Counterparty risk externality: Centralized versus over-the-counter markets. *Journal of Economic Theory* 149, 153–182.
- Bernanke, B. (1990). Clearing and settlement during the crash. *Review of Financial Studies* 3, 133–151.
- Bernstein, A., E. Hughson, and M. Weidenmier (2014). Counterparty risk and the establishment of the New York Stock Exchange clearinghouse. *Working Paper*.
- Biais, B., F. Heider, and M. Hoerova (2012). Clearing, counterparty risk and aggregate risk. *IMF Economic Review* 60, 193–222.
- Biais, B., F. Heider, and M. Hoerova (2016). Risk-sharing or risk-taking? Counterparty risk, incentives and margins. *Journal of Finance* 71, 1669–1698.
- Boissel, C., F. Derrien, E. Örs, and D. Thesmar (2016). Sovereign crises and bank financing: Evidence from the European repo market. *Journal of Financial Economics*.
- CLAM (1971). Règlement de la Caisse de Liquidation des Affaires de Marchandises à Paris.
- Cruz Lopez, J., C. Hurlin, J. H. Harris, and C. Pérignon (2016). CoMargin. *Journal of Financial and Quantitative Analysis* (forthcoming).
- Davison, I. H. (1988). *The Operation and regulation of the Hong Kong securities industry*. Report of the Securities Review Committee. 27 May 1988.
- Duffie, D. (2015). Resolution of failing central counterparties. In T. Jackson, K. Scott, and J. E. Taylor (Eds.), *Making Failure Feasible: How Bankruptcy Reform Can End 'Too Big To Fail*. Hoover Institution Press.
- Duffie, D., M. Scheicher, and G. Vuillemeys (2015). Central clearing and collateral demand. *Journal of Financial Economics* 116, 237–256.
- Duffie, D. and H. Zhu (2011). Does a central clearing counterparty reduce counterparty risk? *Review of Asset Pricing Studies* 1, 74–95.

- Elliott, D. (2013). Central counterparty loss-allocation rules. *Bank of England Financial Stability Paper* (20).
- Faccio, M., M. Marchina, and R. Mura (2011). Large shareholder diversification and corporate risk-taking. *Review of Financial Studies* 24, 3601–3641.
- Franks, J. R. and K. G. Nyborg (1996). Control rights, debt structure, and the loss of private benefits: The case of the u.k. insolvency code. *Review of Financial Studies* 9, 1165–1210.
- Gregory, J. (2014). *Central Counterparties: Mandatory Central Clearing and Initial Margin Requirements for OTC Derivatives* (1st ed.). Wiley.
- Hardouvelis, G. A. and D. Kim (1995). Margin requirements, price fluctuations, and market participation in metal futures. *Journal of Money, Credit and Banking* 27, 659–671.
- Hardouvelis, G. A. and S. Peristiani (1992). Margin requirements, speculative trading, and stock price fluctuations: The case of Japan. *Quarterly Journal of Economics* 107, 1333–1370.
- Jensen, M. C. and W. H. Meckling (1976). Theory of the firm: Managerial behavior, agency cost, and capital structure. *Journal of Financial Economics* 3, 305–360.
- Koepl, T., C. Monnet, and T. Temzelides (2012). Optimal clearing arrangements for financial trades. *Journal of Financial Economics* 103, 189–203.
- Leland, H. E. (1998). Agency costs, risk management, and capital structure. *Journal of Finance* 53, 1213–1243.
- Loon, Y. C. and Z. K. Zhong (2014). The impact of central clearing on counterparty risk, liquidity, and trading: Evidence from the credit default swap market. *Journal of Financial Economics* 112, 91–115.
- MacKinlay, A. C. (1997). Event studies in economics and finance. *Journal of Economic Literature* 35, 13–3.

- Menu, J. (1980). L'activité financière des bourses de commerce et des marchés à terme. In *Journal Officiel de la République Française – Avis et rapports du Conseil Economique et Social*. 5 August 1980.
- Norman, P. (2011). *The Risk Controllers: Central Counterparty Clearing in Globalized Financial Markets* (1st ed.). Wiley.
- Saclé, A. and M. Goldschmidt (1974). *Le marché à terme* (1st ed.). Les Editions d'organisation.
- Simon, Y. (1981). *Bourses de commerce et marchés à terme de marchandise* (2nd ed.). Dalloz.
- Tardieu, G. and F. Porteu de la Morandière (1974). *La Bourse de commerce de Paris* (2nd ed.). L. G. D. J.

Table 1 – Descriptive statistics on sugar futures brokers and investors

This table provides descriptive statistics on sugar futures brokers and investors. Panel A describes registered commodity brokers (35 institutions) plus the London-based International Commodities Clearing House. Exposures are described as of December 2nd, 1974, i.e., the date on which the default of Nataf was declared, before the market was temporarily closed. Panel B describes individual investors, as reflected in sub-accounts opened and managed by brokers in the name of their individual clients. We consider that a broker/investor holds a long (resp. short) position if the number of future contracts bought is strictly larger (resp. strictly lower) than the number of future contracts sold, regardless of the market value of his portfolio. The total number of brokers/investors holding long and short positions, as well as the total number of brokers/investors realizing gains or losses, do not sum up to the total number of brokers/investors, due to the existence of accounts with a balanced position. See Appendix B for details on the data.

---

*Panel A: Registered commodity brokers*

Number of brokers + affiliated CCP	36
<i>Of which:</i>	
Foreign	6
Holding accounts on behalf of individual investors	18
Holding long positions on December 2nd, 1974	24
Holding short positions on December 2nd, 1974	12
Realizing losses given prices on December 2nd, 1974	11
Realizing gains given prices on December 2nd, 1974	22

*Panel B: Retail investors*

Number of investor sub-accounts with the CLAM	683
<i>Of which:</i>	
Holding long positions on December 2nd, 1974	566
Holding short positions on December 2nd, 1974	18
Realizing losses given prices on December 2nd, 1974	636
Realizing gains given prices on December 2nd, 1974	37

---



Table 2 – Event study around initial margin increases

This table performs an event study on the CLAM's stock price around increases in initial margin requirements in 1974. The date of the event is denoted  $\tau$  and we focus on an event window covering five days before and after the event. Panel A estimates the main specification, using cumulative abnormal returns over the entire event window. Abnormal returns are estimated using a one-factor market model estimated in the 300 trading days preceding each event window. Panel B provides a number of robustness checks. The first specification includes the large increase in margins of January 1974 as an additional event (see footnote 10). The second specification uses abnormal returns estimated in the 300 trading days preceding the first event window. The third specification uses abnormal returns estimated using a 2-factor model, where the second factor is the return on an index for financial firms.  $p$ -values are in parentheses. \*, \*\* and \*\*\* denote respectively statistical significance at the 10%, 5% and 1% levels. See Appendix B for details on the data.

*Panel A: Baseline specification*

	Cumulative abnormal return	95% confidence interval	$p$ -value
$\tau - 5$	-0.001	[ -0.014 ; 0.011 ]	0.590
$\tau - 4$	0.001	[ -0.020 ; 0.021 ]	0.471
$\tau - 3$	-0.000	[ -0.021 ; 0.020 ]	0.521
$\tau - 2$	-0.004	[ -0.028 ; 0.020 ]	0.658
$\tau - 1$	-0.000	[ -0.028 ; 0.028 ]	0.504
$\tau$	0.006	[ -0.025 ; 0.036 ]	0.336
$\tau + 1$	0.006	[ -0.025 ; 0.036 ]	0.331
$\tau + 2$	0.013*	[ -0.009 ; 0.035 ]	0.097
$\tau + 3$	0.017**	[ 0.001 ; 0.034 ]	0.022
$\tau + 4$	0.013*	[ -0.005 ; 0.032 ]	0.067
$\tau + 5$	0.023***	[ 0.007 ; 0.039 ]	0.006

*Panel B: Robustness checks*

	Incl. January event		With pre-1974 beta		2-factor model	
$\tau$	0.005	(0.125)	0.005	(0.152)	0.006	(0.141)
$\tau + 1$	0.008*	(0.063)	0.004	(0.179)	0.005	(0.130)
$\tau + 2$	0.015**	(0.013)	0.012**	(0.044)	0.013**	(0.031)
$\tau + 3$	0.017**	(0.032)	0.016*	(0.068)	0.017*	(0.055)
$\tau + 4$	0.014	(0.137)	0.011	(0.214)	0.013	(0.169)
$\tau + 5$	0.022**	(0.037)	0.020*	(0.075)	0.023*	(0.054)

Table 3 – Execution price of orders by Nataf on behalf of its clients

This table regresses the execution price of orders by Nataf on behalf of its clients on measures of exposures by these clients to the collapse in sugar prices. Panel A and B are respectively for buy and sell orders. The first measure of exposure is the average execution price of pre-existing trades for each client. It captures how quickly this client’s balance turns negative when prices fall. The second measure of exposure is the size of an investor’s pre-existing position, expressed in number of contracts. We include a measure of the size of each trade as a control variable. D and MAT correspond respectively to trading day and to contract maturity fixed effects.  $p$ -values are in parentheses. \*, \*\* and \*\*\* denote respectively statistical significance at the 10%, 5% and 1% levels. See Appendix B for details on the data.

*Panel A: Buy orders*

	Dependent variable: Execution price			
Average execution price of existing trades	-0.020** (0.028)	-0.016* (0.057)		
Size of existing position			-0.279*** (0.000)	-0.247*** (0.000)
Volume of trade			-0.185*** (0.000)	-0.097** (0.027)
N. Obs.	69	69	74	74
$R^2$	0.993	0.995	0.995	0.995
Fixed effects	D, MAT	D, MAT	D, MAT	D, MAT

*Panel B: Sell orders*

	Dependent variable: Execution price			
Average execution price of existing trades	0.034 (0.192)	0.062 (0.154)		
Size of existing position			0.052 (0.625)	0.238 (0.435)
Volume of trade			-0.080 (0.191)	-0.054 (0.427)
N. Obs.	33	33	39	39
$R^2$	0.983	0.985	0.983	0.983
Fixed effects	D, MAT	D, MAT	D, MAT	D, MAT

Figure 1 – Schematic representation of the clearinghouse

This figure provides a schematic representation of the clearing process in the Paris Commodity Exchange. Sellers and buyers of sugar futures are represented respectively in green and pink. Based on the most common exposures observed in the data, sugar professionals are typically sellers and individual investors are typically buyers. Each broker or professional participant holds a deposit account on the balance sheet of the CLAM, represented as a square. This account is used to deposit initial and variation margins. Individual investors, or clients, necessarily trade through a registered broker. They may either pay margin through the main broker account (Clients 2, 3 and 4) or hold a separate sub-account in their name in the books of the CLAM, opened at the demand of, and managed by, their broker (Client 1).

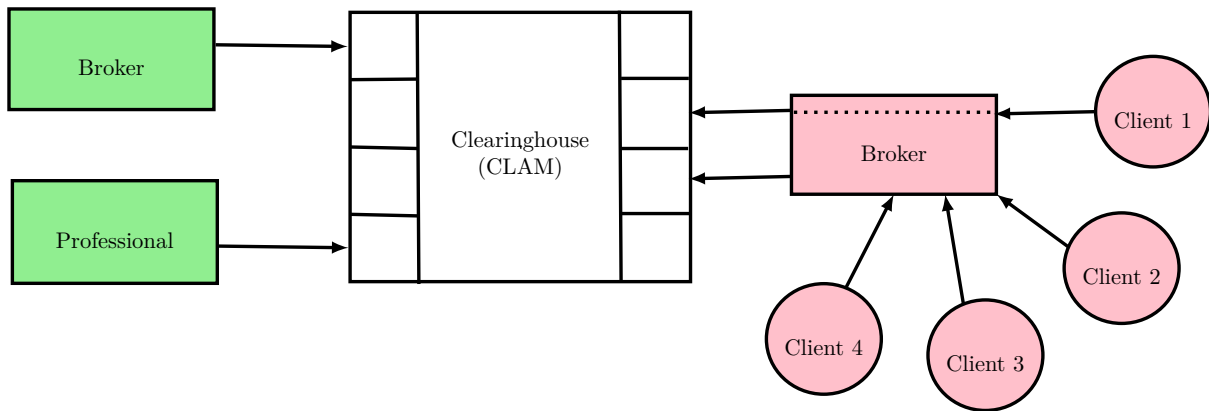
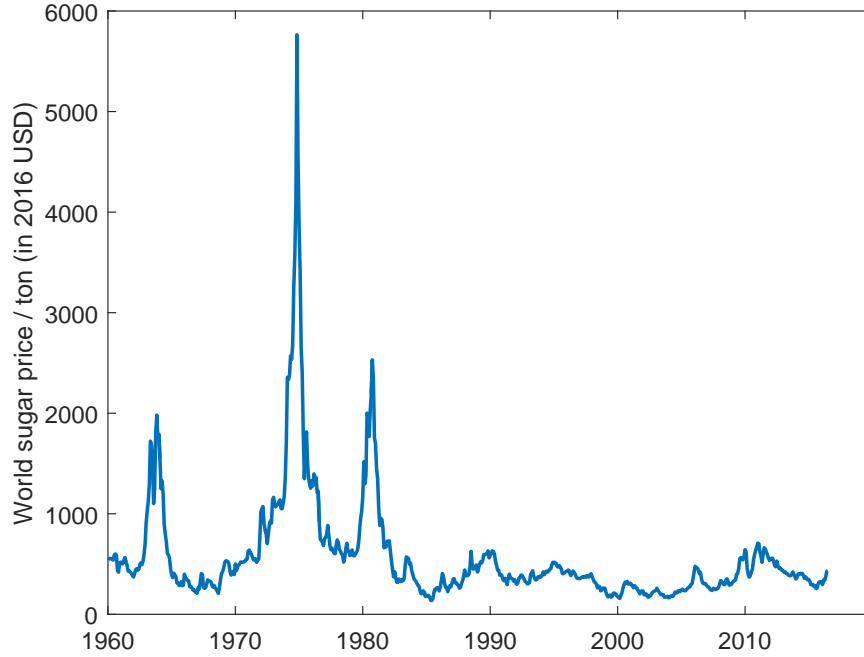

Figure 2 – Sugar price

This figure plots the price of sugar. Panel A plots the world sugar price in the spot market over the 1960-2016 period, at a monthly frequency, expressed in 2016 USD per ton. Data are obtained in nominal terms from the World Bank Global Economic Monitor Database, and converted to real terms using the US consumer price index obtained from the Saint-Louis Federal Reserve' FRED database (series identifier: CPIAUCSL). Panel B plots the spot and nearest-term future sugar prices in Paris over the period from January 1973 to June 1975, at a daily frequency, in current FRF per ton. Data are collected from *Les Echos*. See Appendix B for details on the data.

Panel A: World sugar price, 1960-2016



Panel B: Spot and future prices in Paris, 1974-1975

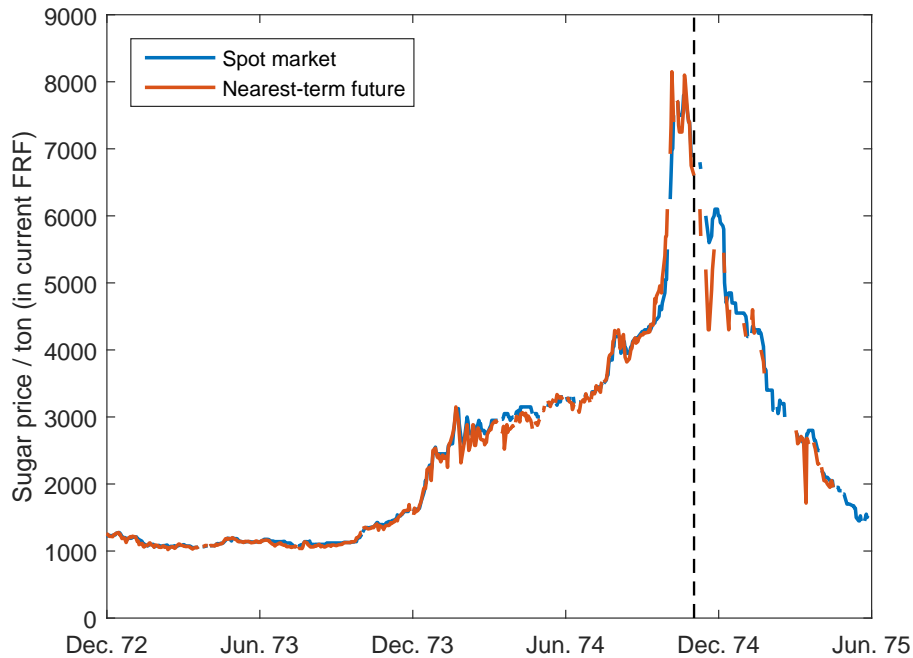
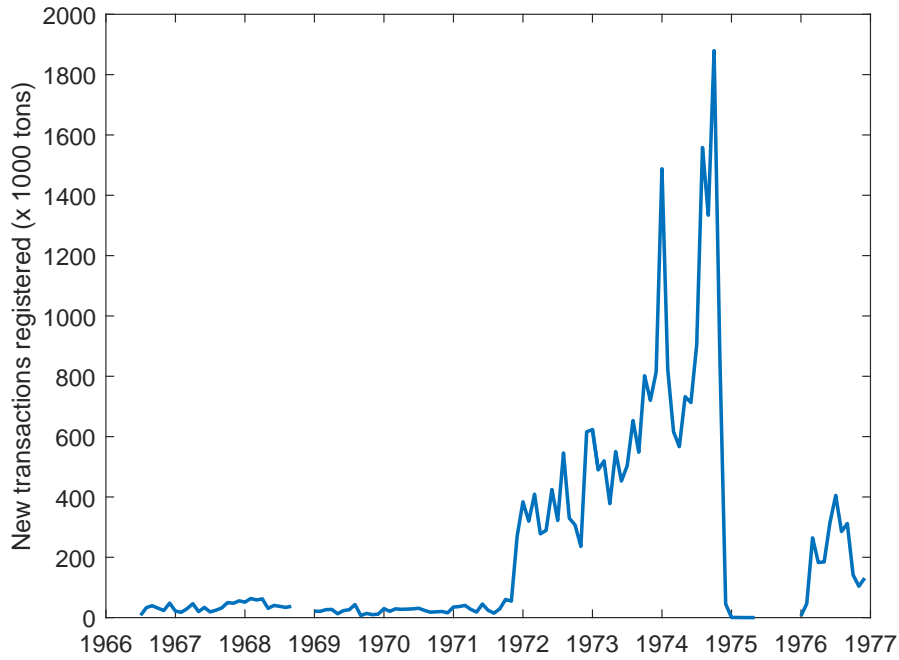

Figure 3 – New transactions registered, 1966-1977

This figure plots the volume of transactions in the Paris Commodity Exchange, registered at the CLAM. Data are at a monthly frequency over the 1966-1977 period. Panel A plots the number of new transactions registered in the white sugar market after the introduction of the main future contract (“contract n°2”) starting from its introduction in July 1966. The transaction volume is expressed in thousand tons of white sugar. Panel B plots the number of new transactions registered in the cocoa and coffee markets, expressed in thousand tons of cocoa and coffee respectively. Trading on coffee futures started in December 1972. Starting in 1976, data correspond to transactions registered at the *Banque Centrale de Compensation*, the successor of the CLAM. See Appendix B for details on the data.

Panel A: New transactions registered - Sugar market



Panel B: New transactions registered - Coffee and cocoa markets

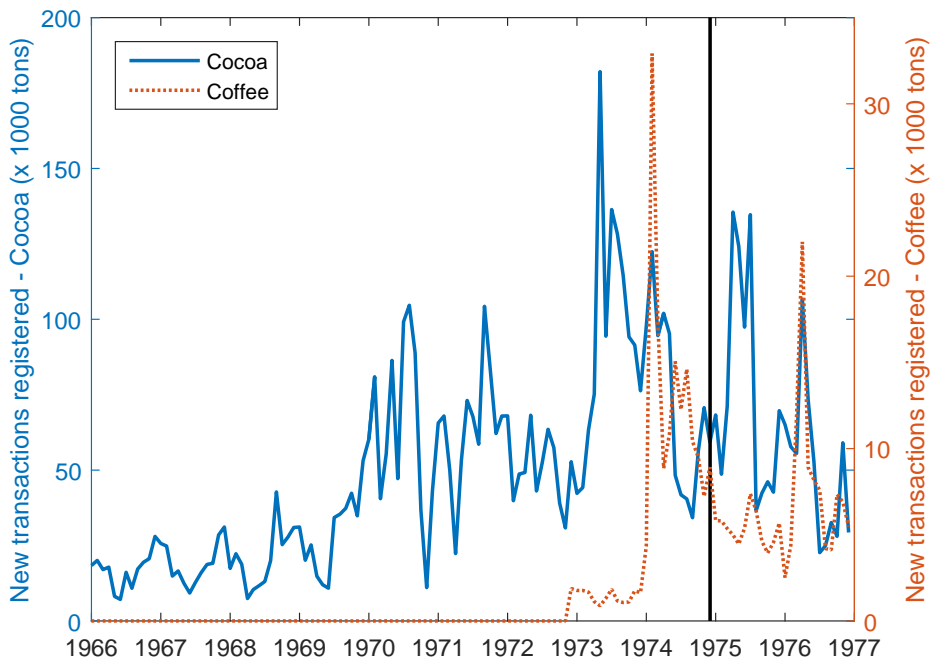

Figure 4 – Initial margin requirement in 1974

This figure plots the initial margin required by the CLAM from November 1973 to the early December 1974. Panel A plots the absolute level of initial margin required, expressed in FRF per ton of sugar. Panel B normalized this margin requirement by the price of the nearest-term sugar future in the Paris market. Data on initial margin requirements are obtained from documents in the National Archives, and data on futures prices from *Les Echos*. See Appendix B for details on the data.

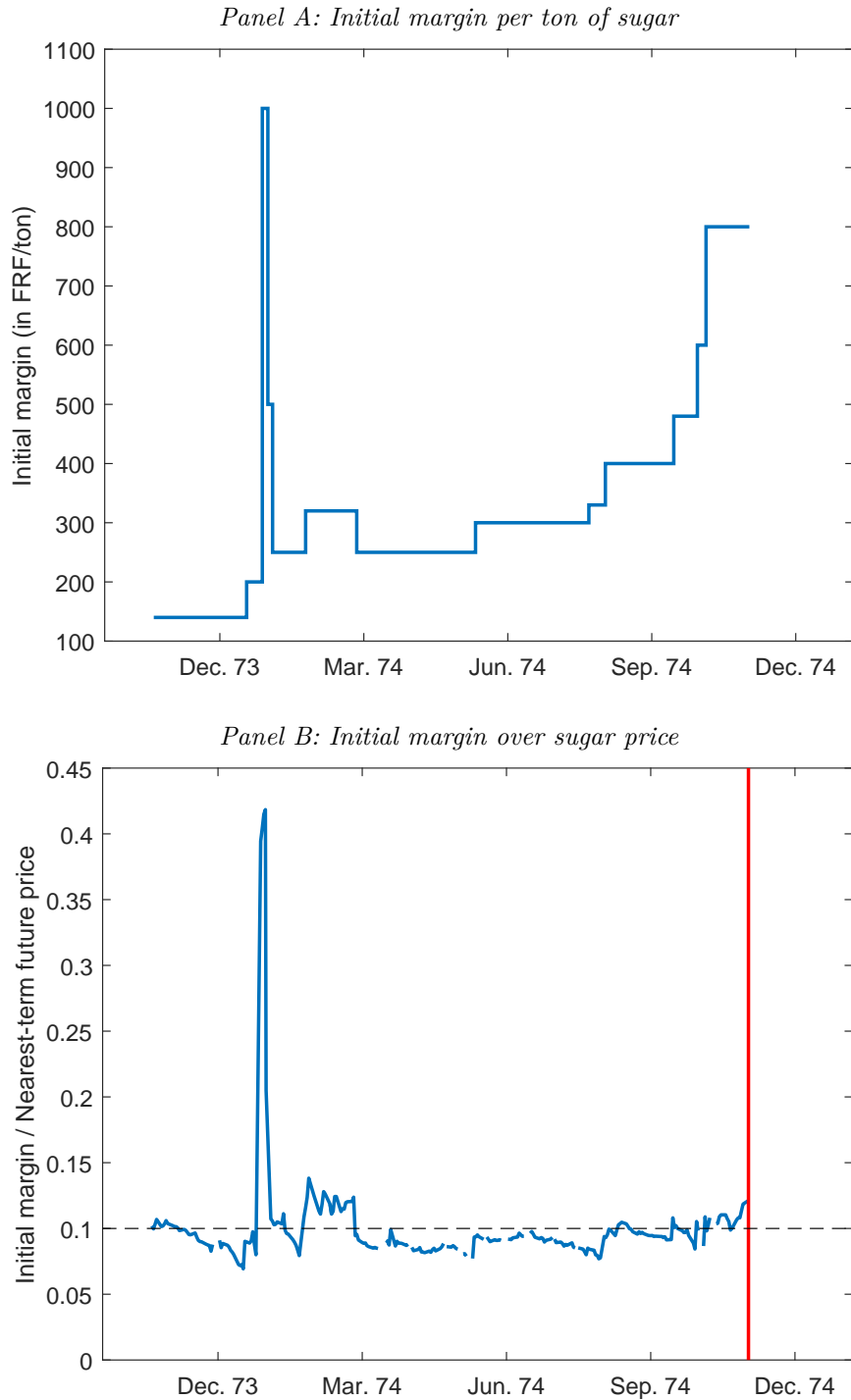

Figure 5 – Stock price of the CLAM

This figure plots the stock price of the CLAM at a daily frequency. Panel A plots the stock price over the period from February 1966 to December 1975. Blank spaces correspond to days on which there is no trading recorded and there is no available data on bids and asks. Panel B plots the CLAM stock price from January 1974 to May 1975. The shaded area corresponds to a period of strike in the Paris Stock Exchange, during which there are no quoted prices (28th March to 8th May 1974). The first vertical line corresponds to the highest sugar price (21st November 1974) and the second vertical line corresponds to the failure of Nataf (2nd December 1974), which leads to the closure of the sugar futures market. See Appendix B for details on the data.

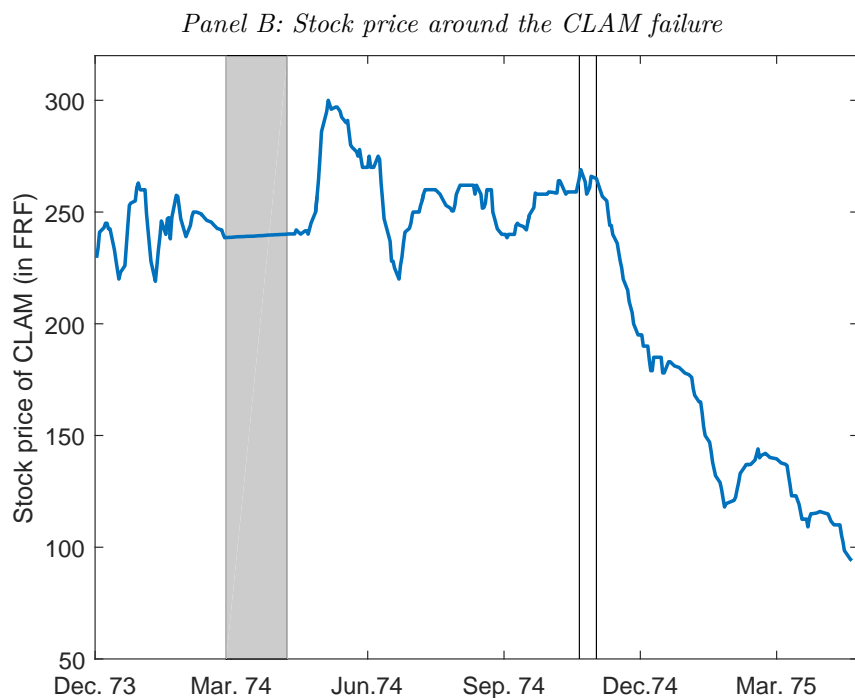
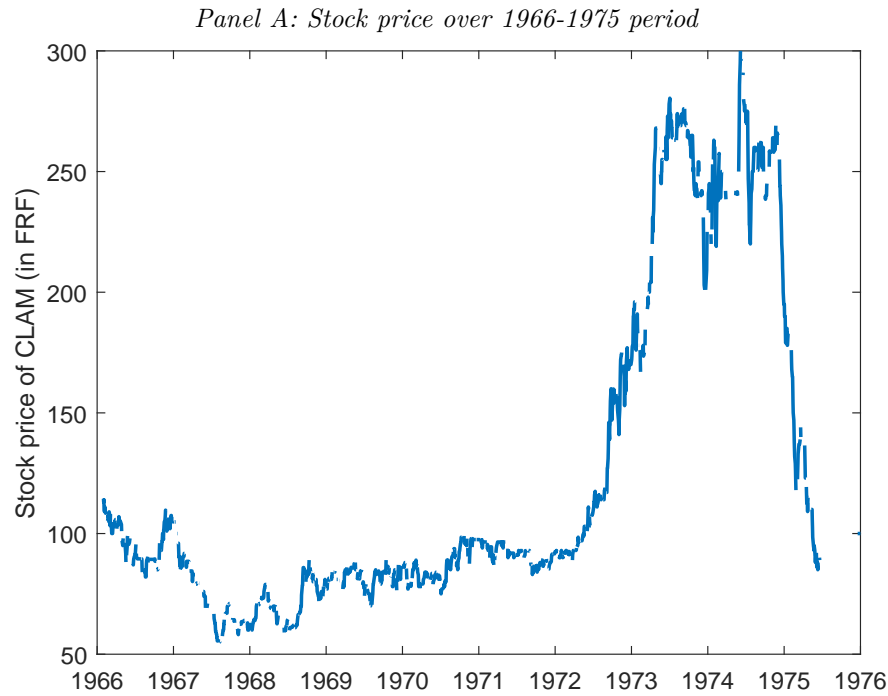

Figure 6 – Balance on Nataf’s account (September - December 1974)

This figure depicts Nataf’s account at the CLAM in the three months preceding its distress, from early September to early December 1974. Panel A breaks down the assets used to meet initial and variation margins. Assets comprise bank guarantees (red line) and deposited capital, i.e., cash (difference between the blue and the red line). These assets are used to pay for initial margins (yellow line) and variation margins (difference between the yellow and purple lines). Panel B plots the balance on Nataf’s account (in blue). The balance is defined as in Equation (1). The red line plots Nataf’s balance under the assumption that initial margins can be used to meet variation margins call. The vertical line corresponds to November 21st, when sugar prices reached their highest level. Data are obtained from the archives of the Paris Chamber of Commerce. See Appendix B for details.

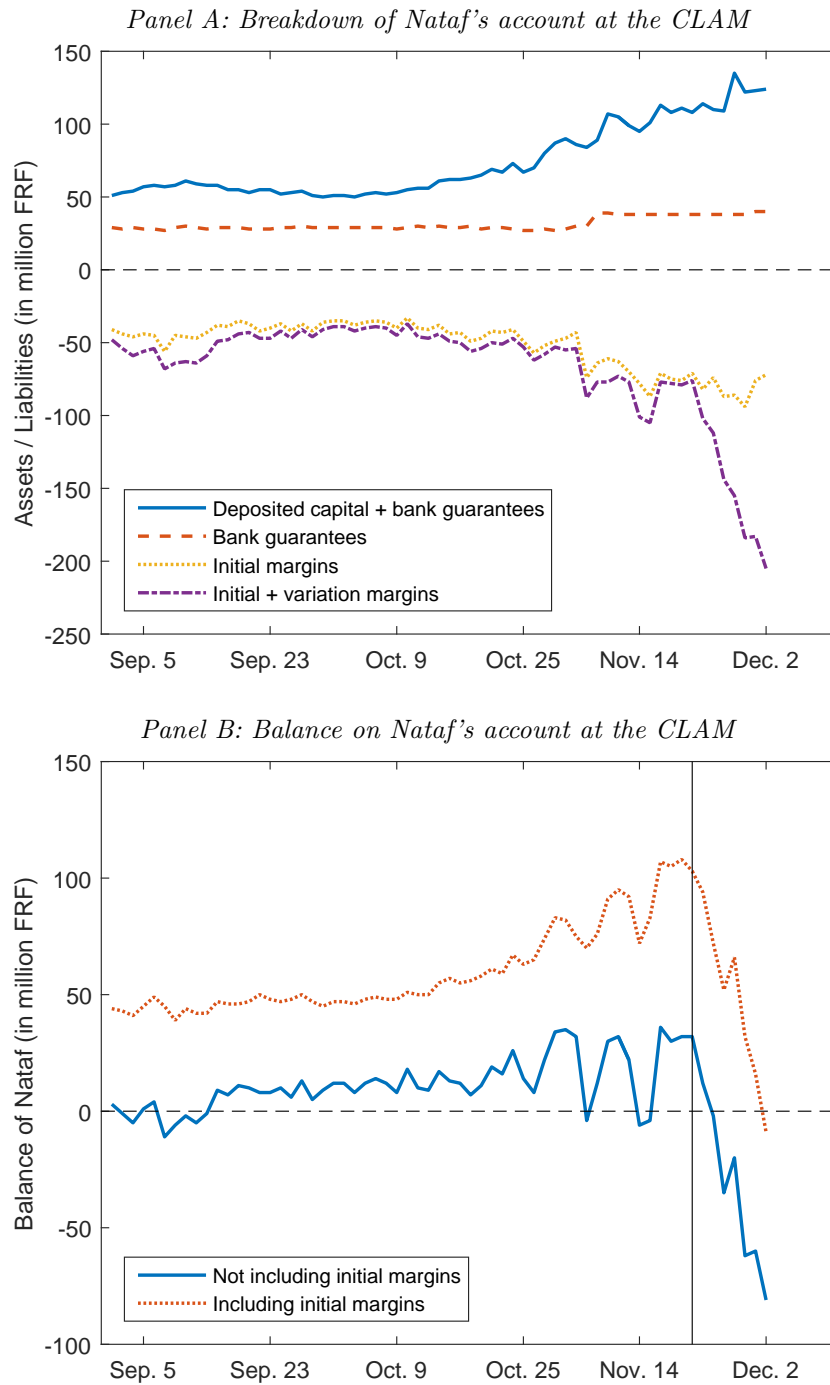



Figure 7 – Event study around initial margin increases

This figure plots the CLAM's cumulative abnormal stock return over a period starting five days before increases of initial margin requirements and ending five days after these events. It is based on all increases in initial margins motivated by changes in underlying exposure during the year 1974, i.e., eight events. The calculation of abnormal returns is based on a one-factor market model, estimated over the 300 trading days preceding, but not including, each event window. The shaded area represents 90% confidence intervals. See Section 5 for additional details on the event study and Appendix B for details on the data.

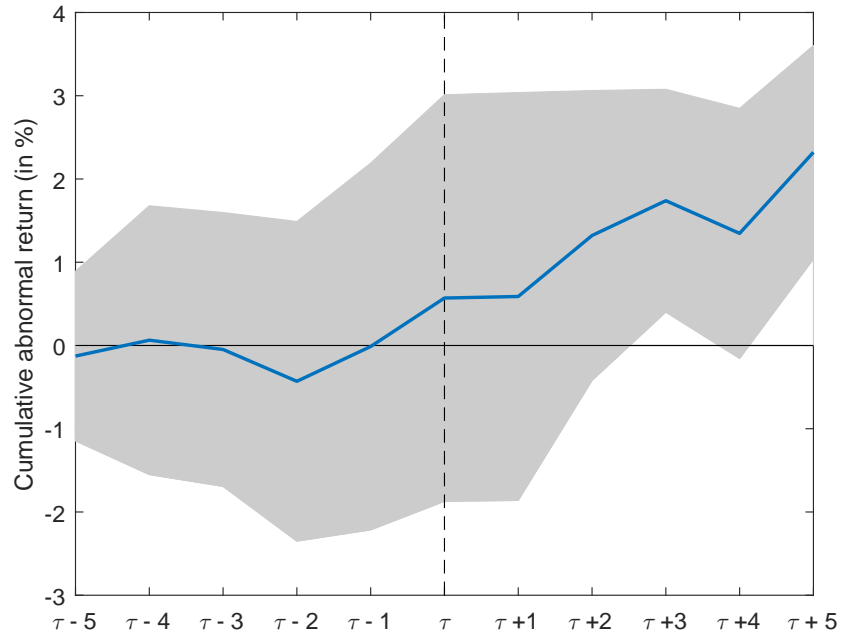
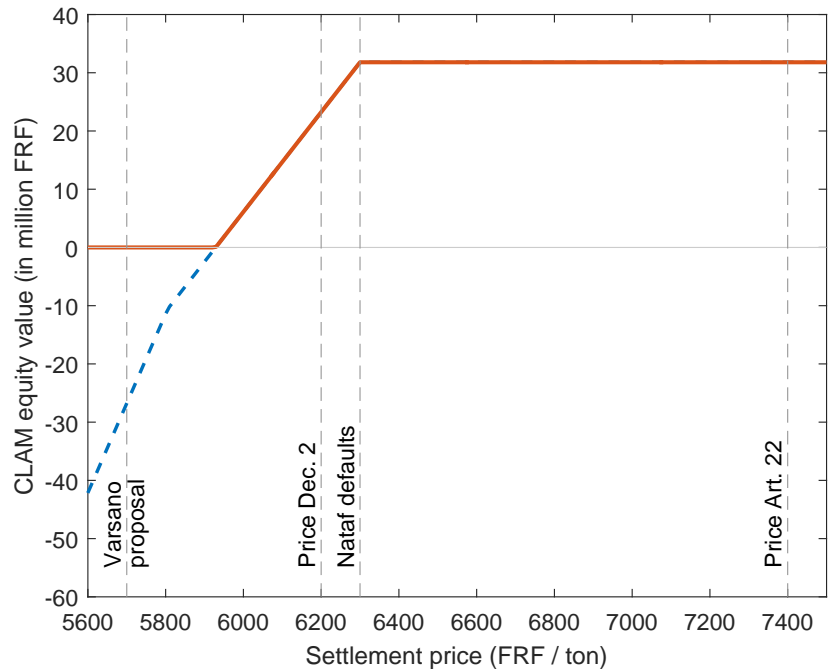

Figure 8 – Equity value of the CLAM

This figure plots the market value of the CLAM’s equity, in million FRF, as a function of the settlement price for outstanding exposures on December 2nd, 1974. The calculation of the equity market value is based on the CLAM’s stock price on December 2nd, 1974. For any settlement price above 6,300 FRF (including the price mandated by Article 22 of the sugar market’s rulebook, i.e., 7,400 FRF), the balance on Nataf’s account is positive and it does not default. For a settlement based on the price prevailing on Dec. 2nd (6,200 FRF), the CLAM incurs a loss of 8.1 million FRF but does not default. For any settlement price below 5,920 FRF, the loss due to Nataf’s default is larger than the CLAM’s equity. In this region, the blue line plots total losses incurred by equity, while the orange line plots the equity value under limited liability. A second kink at 5,820 corresponds to the default of additional registered brokers if prices fall below this threshold. The implementation of the Varsano proposal (settlement at 5,700 FRF) does not allow the CLAM to absorb losses. See Appendix B for details on the data.



## A Additional institutional description

This appendix provides additional institutional details on the Paris Commodity Exchange and on the CLAM. A more general description of the exchange can be found in [Tardieu and Porteu de la Morandière \(1974\)](#), [Saclé and Goldschmidt \(1974\)](#), [Menu \(1980\)](#) and [Simon \(1981\)](#).

### Price fluctuation limits

The Paris Commodity Exchange featured price fluctuation limits, called “limit-up” and “limit-down”. In any given trading day, prices could not move beyond these limits, defined with respect to the previous day’s settlement price. Until November 1974, limits up and down on sugar contracts were close to proportional to the level of settlement prices. For a price below or equal to 250 FRF, the limit was 25 FRF; within the {251 FRF, 450 FRF} bucket, it was 35 FRF; within the {451 FRF, 650 FRF} bucket, it was 55 FRF, and so on. Starting on November 8, 1974, the proportional limit was changed to a constant limit of 300 FRF per trading day. Since future prices on that day (for the nearest-term delivery) were 7,400 FRF per ton, the proportional limit was 745 FRF. Therefore, the change substantially narrowed price fluctuation limits. Similar limits still exist on most commodity future exchanges worldwide.

### Membership requirements

The CLAM did not have membership requirements that it could directly control. However, there were indirect membership requirements, since clearing members (with few exceptions) had to be registered brokers. Becoming a registered broker required demonstrating sufficient financial strength. The precise nature of the requirements was managed by the professional association of registered commodity brokers (*Compagnie des commissionnaires agréés*). Among other requirements, registered brokers needed to show sufficient financial strength, with an equity of at least 1 million FRF. This requirement has been raised several times in the years preceding the sugar crisis.

## Default fund

The CLAM does not benefit from any default fund. Separately, the professional association of registered commodity brokers manages a fund aimed at protecting individual investors against the default of their broker (*Caisse Mutuelle de Garantie*). Indeed, brokers do not post margin to their clients. The minimum amount held within this fund is 5 million FRF, and its maximum amount is 50 million FRF. An above limit is in place to ensure that surviving members do not assume unlimited liabilities for the default of other members. When the fund has to be replenished, contributions are proportional to the turnover of each member over the past 12 months.

## Clearing fees

To register a transaction, the CLAM charges a fee per ton of sugar. Clearing fees do not depend on the level of sugar prices. In addition to clearing fees, a tax is also levied on each trade, equal to 1/10,000 of the notional value of each transaction.

## Bank guarantees

The use of bank guarantees to cover margin payments was widespread. In a typical arrangement, a register broker brings to the CLAM a letter of credit by which a bank commits to meet the broker's payments upon demand, for a certain period of time and up until a maximum limit. When bank guarantees are used, the CLAM earns interest on the amount drawn. The CLAM can decide to refuse certain bank guarantees. For example, in the third quarter of 1974, it put a cap on the guarantees that could be provided by one bank (*Banque Vernes et Commerciale de Paris*), which had issued letters of credit for an amount greater than its equity. Based on data covering all brokers after the closure of the market, we find that 28 out of 35 brokers were pledging bank guarantees to the CLAM, for a total amount of 384 million FRF. In contrast, the use of securities to meet variation margin calls was extremely limited. Only one broker was posting securities to the CLAM, for an amount of 350,000 FRF.

## **Position limits**

The CLAM did not enforce limits on the position that each registered broker could take. Throughout the history of the exchange, it has often been the case that a handful of registered brokers concentrate a large share of the open position. Therefore, the large exposure held by Nataf at the end of 1974 was not be completely unusual. It should be reminded that, to an overwhelming extent, registered brokers do not trade on their own account, but on behalf of clients, for which they execute orders. As such, their balance sheet resembles that of a CCP, and their net open position is usually equal to zero or small. Also note that the share of the open position of a registered broker within the open position of the clearinghouse varies not only because of new trades, but also because other clearing members close positions or reduce trading. This factor partly explains the growth of Nataf's position.

## **Board**

Even though it is a corporation, the board of the CLAM does not primarily represent its equity holders. This is a consequence of the fact that it has a monopoly status and operates as a public utility for the Paris Commodity Exchange. According to its statutes, its board is composed of 12 members, which should receive the approval of the Department of Commerce. These members comprise four registered brokers, five representatives of commodity professionals, and three representatives a large banking groups. A representative of the Department of Commerce attends all board meetings.

## B Data sources

Documentation and data are obtained from several archive sources.

- **Archives of the French Department of Commerce**, located in the National Archives in Pierrefitte-Sur-Seine (*Archives nationales*), in particular files 19910031/1 to 19910031/23 (*Commerce et Artisanat ; Direction du commerce intérieur ; Sous-direction activités commerciales; Marchés à terme de marchandises, 1939-1989*). These archives contain a large number of documents, including legal and statistical information on the Paris Commodity Exchange, confidential policy briefs, reports and preparatory notes from meetings involving officials at the Department of Commerce. It also contains copies of original documents produced by the CLAM and by Nataf. A large number of judicial documents are also obtained.
- **Archives of the Paris Chamber of Commerce** (*Chambre de Commerce et d'Industrie de Paris*), located in Paris. Most of the relevant documents are in boxes numbered 135-W. They contain a large variety of legal and statistical information, as well as notes and reports. Since the Chamber of Commerce was involved in the supervision of the Paris Commodity Exchange, we also find a number of supervisory reports pertaining to registered brokers.
- **Archives of the French Ministry of Finance** (*Centre des Affaires Economiques et Financières*, or *CAEF*), located in Savigny-le-Temple. We hand-collect daily stock market data for the CLAM, from February 1966 to December 1975, including the stock price, dividend payments, and the number of shares outstanding. We consistently use the ex-dividend stock price. A stock price for the CLAM is available before 1966. However, the main white sugar future contract (so-called “contract n°2”) did not trade before July 1966. All stock price data are from the *Cours authentique et officiel*, the daily newspaper published by the professional association managing the Paris Stock Exchange (*Compagnie des agents de change*). From the same source, we also collect daily data on stock market indices for the overall market

and for the financial sector, over the 1972-1975 period. From the CAEF, we finally collect a few notes on the sugar crisis in boxes numbered 1A-0000371/1 and 2, and 1A-0000204/1.

- **Archives of the Bank of France** (*Banque de France*), located in Paris. We obtain supervisory reports produced by the Bank of France about the CLAM. This includes a detailed report by J. Le Poupon (*Commission de Contrôle des Banques*, 22 April 1975), and a number of other notes. The archives also contain detailed balance sheet data for the CLAM, at a quarterly frequency, and over an extended period of time, as well as many annual reports by the CLAM.
- **National Library of France** (*Bibliothèque nationale de France*), located in Paris. From the economic newspaper *Les Echos*, we hand-collect daily data on spot and future sugar prices in the Paris, London and New York commodity markets. Prices are broken down by the maturity of each contract. These data are collected for years 1974 and 1975.
- **French Economic, Social and Environmental Council** (*Conseil économique, social et environnemental*), located in Paris. We obtain the report by [Menu \(1980\)](#) in original form, as published in the *Journal Officiel*, the official gazette of the French Republic.

Table A1 – Timeline of events during the 1974 sugar crisis

Date	Event
21 Nov. 1974	Sugar prices hit their highest level, 8,150 FRF/ton.
21 Nov. - 2 Dec. 1974	Sugar prices hit the limit down 7 times. Long investors cannot close their open positions. Brokers cannot liquidate positions of investors not responding to margin calls.
2 Dec. 1974	A broker holding 56.8% of the (long) open position, Maurice Nataf, is declared in default. Other brokers are close to default.
3 Dec. 1974	The quotation of future prices is suspended by the minister of commerce, with the support of the CLAM and of the professional association of registered brokers. They invoke Article 22 of the sugar market's rule book. According to this article, if quotations are suspended because of exceptional circumstances, existing trades must be cleared based on the average settlement price prevailing over the past 20 trading days. The market's technical committee opposes the suspension of trading.
5 Dec. 1974	The market re-opens. The CLAM announces on Dec. 6th that it will not register new trades before a settlement price for existing positions is fixed by the technical committee.
11 Dec. 1974	The Paris Commercial Court ( <i>Tribunal de commerce</i> ) validates the suspension of trading and the settlement of existing positions based on Article 22. The average price over the past 20 trading days (7,459 FRF for the March 1975 maturity) is higher than the settlement price prevailing on Dec 2nd (6,217 FRF). This decision favors investors with long positions against hedgers (short positions). Based on this settlement price, both Nataf and the CLAM would not default. Therefore, both defend the implementation of Article 22. After the decision of the Paris Commercial Court, the CLAM immediately liquidates open positions based on Article 22, and call margins from sellers. The sellers refuse to pay. Several sugar professionals appeal the decision on the next day.
4 Feb. 1975	The Paris Court of Appeal invalidates the earlier decision by the Paris Commercial Court. The settlement price must be based on actual market prices, not computed on the basis of Article 22. This ruling favors hedgers (short positions) against retail investors (long positions). A settlement of contracts based on market prices would induce the CLAM to default, due to losses on its exposure to Nataf and possibly to the default of other brokers.
20 Jun. 1975	The decision of the minister of commerce to suspend trading on Dec. 3 is invalidated by the Council of State ( <i>Conseil d'Etat</i> ), further threatening the CLAM. By that date, sugar prices have been further falling to 1,450 FRF/ton. After this decision, it becomes clear that no recovery can take place, and that the CLAM needs to go through a resolution procedure.
22 Jun. 1975	The French government dismisses the board of the CLAM and appoints an administrator. The liquidation of the CLAM starts.
7 Nov. 1975	An agreement to share losses among all parties and settle contracts is proposed and signed by all parties on Dec. 19.
26 Jan. 1976	The sugar market re-opens with a new clearinghouse.



Table A2 – Ownership structure of the CLAM

This table provides details on the ownership structure of the CLAM, as of end-January 1975. The main source is a confidential report commissioned by the Bank of France after the closure of the sugar market. See Appendix B for details on the data.

Type of shares	Registered shares	
Number of shares	120,000	
Number of shareholders	669	
	Number of shares	% of total shares
Assurances Générales de France (AGF)		
<i>AGF Vie</i>	54,001	45.00
<i>Banque Générale du Phénix</i>	12,000	10.00
<i>La Métropole</i>	3,827	3.19
Union des Assurances de Paris		
<i>Union Capitalisation</i>	2,500	2.08
<i>Le Continent Incendie</i>	184	0.15
Banks		
<i>Paribas</i>	2,518	2.10
<i>Société Générale</i>	3,116	2.60
<i>Crédit Lyonnais</i>	3,054	2.55
Board members		
<i>Gérard Bauche (CEO)</i>	1,200	1.00
<i>Henri Cayre</i>	1,281	1.07
Sugar professionals		
<i>Beghin-Say</i>	1,874	1.56
Individual shareholders		
<i>3 individuals owning &gt; 1% each</i>	7,827	6.52
<i>Other shareholders</i>	26,618	22.18

Table A3 – Allocation of losses and resolution of the CLAM

This table provides details on the allocation of losses during the resolution of the CLAM. Sources: [Simon \(1981\)](#) and archive documents. See Appendix B for details on the archive sources.

Party	Allocation of losses
	<u>CLAM</u>
CLAM	Contributes the entire value of its assets (15 million FRF in liquid assets, 35 million FRF in real estate, 100 million FRF in debt claims).
	<u>Investors</u>
Buyers of sugar futures	Exposures are cleared based on the settlement price of Dec. 2nd (6,217 FRF for the nearest-term future) plus 100 FRF.
Sellers of sugar futures	Exposures are cleared based on the settlement price of Dec. 2nd (6,217 FRF for the nearest-term future) minus 200 FRF.
Nataf clients	Obtain 35% of 6,017 FRF.
International Commodities Clearing House	Exposures are cleared based on the settlement price of Dec. 2nd (6,217 FRF for the nearest-term future) minus 200 FRF.
	<u>Equity holders</u>
Blockholders (AGF and banks)	Sell their shares for 1 FRF per share to a subsidiary of Cr�dit Lyonnais (called SINFIC), and contribute to the creation of the successor CCP.
Minority shareholders	Sell their shares to SINFIC for 100 FRF per share.
	<u>Sugar professionals</u>
Professional association of sugar producers	Contributes 7.5 million FRF.
Professional association of sugar beet producers	Contributes 7.5 million FRF.
	<u>Other stakeholders</u>
Professional association of registered brokers	Contribute 23 million FRF, plus 5 million FRF in the name of the professional association of introducing brokers.

Figure A1 – Open position of the CLAM

This figure plots the open position of the CLAM on sugar futures, at a monthly frequency, from July 1966 to December 1974. The open position corresponds to the net volume of physical sugar or the monetary amount that would change hands if all positions were to be settled on a given day. It captures the exposure of the CLAM, after netting long and short positions for each clearing member. In Panel A, the open position is expressed both in thousand tons (dotted line) and in million FRF (solid line). The exposure in FRF on a given day is obtained by multiplying the exposure in tons by the price of a ton of sugar on that day. In Panel B, we plot the ratio of the open position of the CLAM in FRF, normalized by the market capitalization of the CLAM. See Appendix B for details on the data.

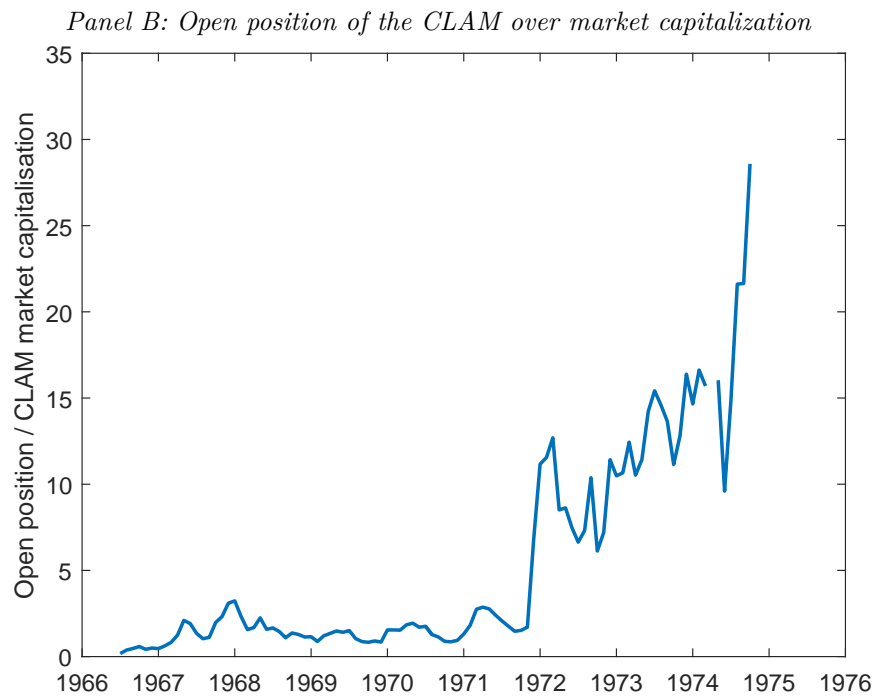
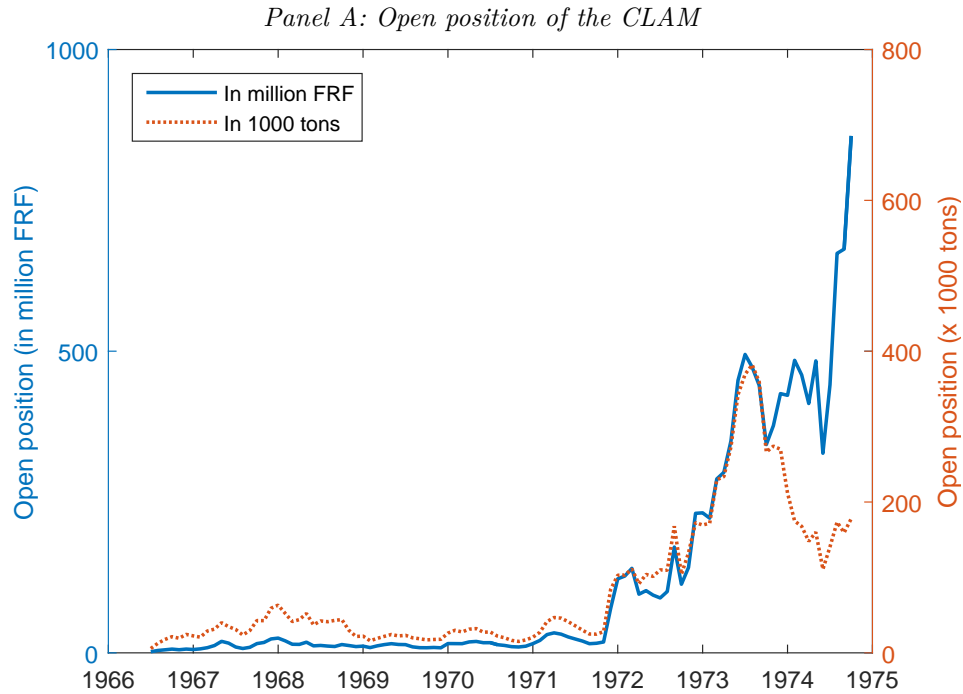

Figure A2 – Volatility of sugar future prices

This figure plots the volatility of the nearest-term future sugar price at a daily frequency over a period from February 1974 to December 1974. Volatility is defined as the standard deviation of log changes in sugar prices over the past 30 trading days (see Equation 2). The dotted vertical line corresponds to December 2nd, 1974, when the default of Nataf was declared. See Appendix B for details on the data.

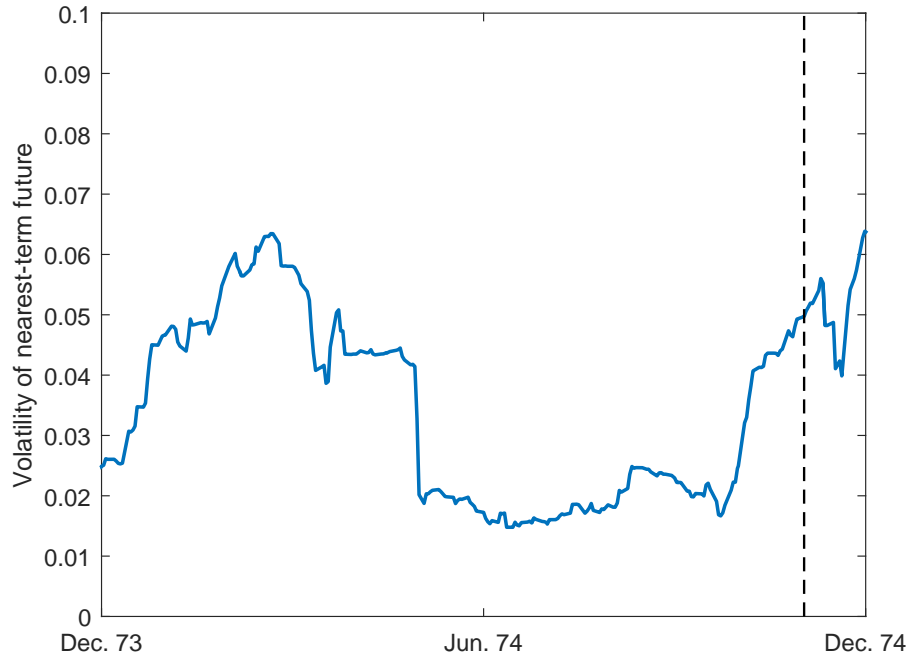

Figure A3 – Stock market indices

This figure plots two stock market indices at a daily frequency from January 1974 to May 1975. The first index (solid line) is a composite index, covering stocks from all sectors; the second index (dotted line) is an index covering only stocks from the financial sector. These indices were computed daily by the professional association managing the Paris Stock Exchange (*Compagnie des agents de change*). The shaded area corresponds to a period of strike in the Paris Stock Exchange, during which there are no quoted prices (28th March to 8th May 1974). The first vertical line corresponds to the highest sugar price (21st November 1974) and the second vertical line corresponds to the failure of Nataf (2nd December 1974), which leads to the closure of the sugar futures market. See Appendix B for details on the data.

